

O'REILLY®

# Designing Data-Intensive Applications

THE BIG IDEAS BEHIND RELIABLE, SCALABLE,  
AND MAINTAINABLE SYSTEMS



**Free  
Chapters**

compliments of



**SCYLLA**

Martin Kleppmann



SCYLLA

# Predictable Low Latencies @ Extreme Throughput

START INSTANTLY

LEARN MORE

Signs you need ScyllaDB for your data-intensive application...

- > Cassandra migraines
- > Scaling impairments
- > Inability to meet SLAs
- > DynamoDB / Bigtable bill shock
- > Painful latency spikes
- > Cloud vendor lock-in



Medium

hulu



STRAVA

Rakuten



---

# Designing Data-Intensive Applications

*The Big Ideas Behind Reliable, Scalable,  
and Maintainable Systems*

This excerpt contains Chapters 3, 5, and 8. The complete book is available on the O'Reilly Online Learning Platform and through other retailers.

*Martin Kleppmann*

## Designing Data-Intensive Applications

by Martin Kleppmann

Copyright © 2017 Martin Kleppmann. All rights reserved.

Printed in the United States of America.

Published by O’Reilly Media, Inc., 1005 Gravenstein Highway North, Sebastopol, CA 95472.

O’Reilly books may be purchased for educational, business, or sales promotional use. Online editions are also available for most titles (<http://oreilly.com>). For more information, contact our corporate/institutional sales department: 800-998-9938 or [corporate@oreilly.com](mailto:corporate@oreilly.com).

**Editors:** Ann Spencer and Marie Beaugureau

**Production Editor:** Kristen Brown

**Copyeditor:** Rachel Head

**Proofreader:** Amanda Kersey

**Indexer:** Ellen Troutman-Zaig

**Interior Designer:** David Futato

**Cover Designer:** Karen Montgomery

**Illustrator:** Rebecca Demarest

March 2017: First Edition

### Revision History for the First Edition

2019-03-15: Sixth Release  
2019-08-09: Seventh Release  
2019-10-11: Eighth Release  
2019-12-06: Ninth Release  
2020-01-24: Tenth Release  
2020-03-27: Eleventh Release  
2020-06-05: Twelfth Release  
2020-07-24: Thirteenth Release  
2020-09-25: Fourteenth Release  
2021-03-26: Fifteenth Release  
2021-06-25: Sixteenth Release

See <http://oreilly.com/catalog/errata.csp?isbn=9781449373320> for release details.

The O’Reilly logo is a registered trademark of O’Reilly Media, Inc. *Designing Data-Intensive Applications*, the cover image, and related trade dress are trademarks of O’Reilly Media, Inc.

While the publisher and the author have used good faith efforts to ensure that the information and instructions contained in this work are accurate, the publisher and the author disclaim all responsibility for errors or omissions, including without limitation responsibility for damages resulting from the use of or reliance on this work. Use of the information and instructions contained in this work is at your own risk. If any code samples or other technology this work contains or describes is subject to open source licenses or the intellectual property rights of others, it is your responsibility to ensure that your use thereof complies with such licenses and/or rights.

This work is part of a collaboration between O’Reilly and ScyllaDB. See our [statement of editorial independence](#).

978-1-449-37332-0

[LSI]

---

# Table of Contents

<b>3. Storage and Retrieval.....</b>	<b>1</b>
Data Structures That Power Your Database	2
Hash Indexes	4
SSTables and LSM-Trees	8
B-Trees	11
Comparing B-Trees and LSM-Trees	15
Other Indexing Structures	17
Transaction Processing or Analytics?	22
Data Warehousing	23
Stars and Snowflakes: Schemas for Analytics	25
Column-Oriented Storage	27
Column Compression	29
Sort Order in Column Storage	31
Writing to Column-Oriented Storage	33
Aggregation: Data Cubes and Materialized Views	33
Summary	35
<b>5. Replication.....</b>	<b>43</b>
Leaders and Followers	44
Synchronous Versus Asynchronous Replication	45
Setting Up New Followers	47
Handling Node Outages	48
Implementation of Replication Logs	50
Problems with Replication Lag	53
Reading Your Own Writes	54
Monotonic Reads	56
Consistent Prefix Reads	57
Solutions for Replication Lag	59

Multi-Leader Replication	60
Use Cases for Multi-Leader Replication	60
Handling Write Conflicts	63
Multi-Leader Replication Topologies	67
Leaderless Replication	69
Writing to the Database When a Node Is Down	69
Limitations of Quorum Consistency	73
Sloppy Quorums and Hinted Handoff	75
Detecting Concurrent Writes	76
Summary	84
<b>8. The Trouble with Distributed Systems.....</b>	<b>91</b>
Faults and Partial Failures	92
Cloud Computing and Supercomputing	93
Unreliable Networks	95
Network Faults in Practice	97
Detecting Faults	98
Timeouts and Unbounded Delays	99
Synchronous Versus Asynchronous Networks	102
Unreliable Clocks	105
Monotonic Versus Time-of-Day Clocks	106
Clock Synchronization and Accuracy	107
Relying on Synchronized Clocks	108
Process Pauses	113
Knowledge, Truth, and Lies	118
The Truth Is Defined by the Majority	118
Byzantine Faults	122
System Model and Reality	124
Summary	128



# OCEAN OF DISTRIBUTED DATA

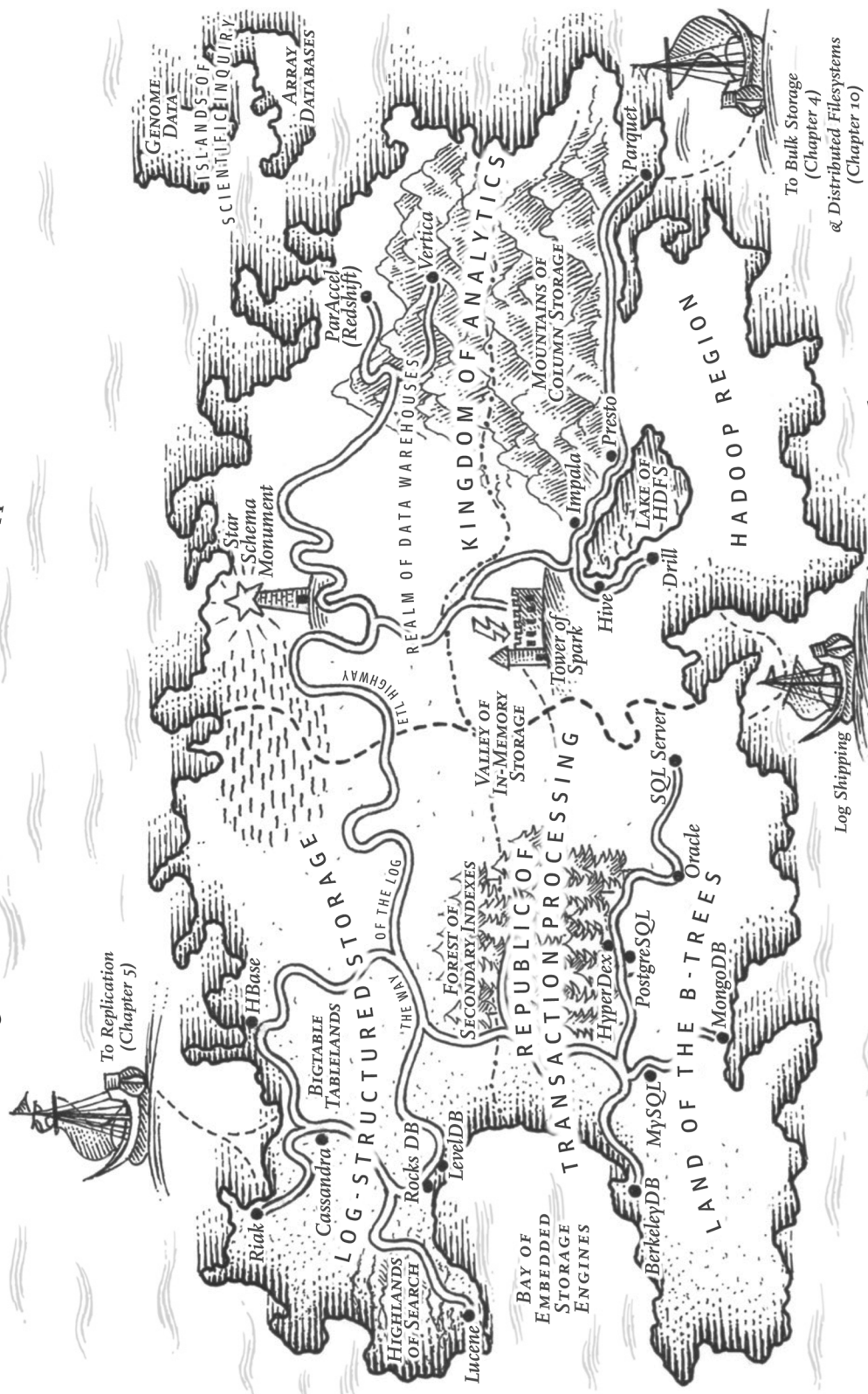

To Replication  
(Chapter 5)

To Bulk Storage  
(Chapter 4)  
& Distributed Filesystems  
(Chapter 10)

Log Shipping

# SEA OF STORAGE & RETRIEVAL



---

# Storage and Retrieval

*Wer Ordnung hält, ist nur zu faul zum Suchen.*

*(If you keep things tidily ordered, you're just too lazy to go searching.)*

—German proverb

On the most fundamental level, a database needs to do two things: when you give it some data, it should store the data, and when you ask it again later, it should give the data back to you.

In Chapter 2 we discussed data models and query languages—i.e., the format in which you (the application developer) give the database your data, and the mechanism by which you can ask for it again later. In this chapter we discuss the same from the database's point of view: how we can store the data that we're given, and how we can find it again when we're asked for it.

Why should you, as an application developer, care how the database handles storage and retrieval internally? You're probably not going to implement your own storage engine from scratch, but you *do* need to select a storage engine that is appropriate for your application, from the many that are available. In order to tune a storage engine to perform well on your kind of workload, you need to have a rough idea of what the storage engine is doing under the hood.

In particular, there is a big difference between storage engines that are optimized for transactional workloads and those that are optimized for analytics. We will explore that distinction later in “[Transaction Processing or Analytics?](#)” on page 22, and in “[Column-Oriented Storage](#)” on page 27 we'll discuss a family of storage engines that is optimized for analytics.

However, first we'll start this chapter by talking about storage engines that are used in the kinds of databases that you're probably familiar with: traditional relational databases, and also most so-called NoSQL databases. We will examine two families of

storage engines: *log-structured* storage engines, and *page-oriented* storage engines such as B-trees.

## Data Structures That Power Your Database

Consider the world's simplest database, implemented as two Bash functions:

```
#!/bin/bash

db_set () {
    echo "$1,$2" >> database
}

db_get () {
    grep "^$1," database | sed -e "s/^$1,//" | tail -n 1
}
```

These two functions implement a key-value store. You can call `db_set key value`, which will store `key` and `value` in the database. The `key` and `value` can be (almost) anything you like—for example, the `value` could be a JSON document. You can then call `db_get key`, which looks up the most recent value associated with that particular `key` and returns it.

And it works:

```
$ db_set 123456 '{"name":"London","attractions":["Big Ben","London Eye"]}'

$ db_set 42 '{"name":"San Francisco","attractions":["Golden Gate Bridge"]}'

$ db_get 42
{"name":"San Francisco","attractions":["Golden Gate Bridge"]}
```

The underlying storage format is very simple: a text file where each line contains a key-value pair, separated by a comma (roughly like a CSV file, ignoring escaping issues). Every call to `db_set` appends to the end of the file, so if you update a key several times, the old versions of the value are not overwritten—you need to look at the last occurrence of a key in a file to find the latest value (hence the `tail -n 1` in `db_get`):

```
$ db_set 42 '{"name":"San Francisco","attractions":["Exploratorium"]}'

$ db_get 42
{"name":"San Francisco","attractions":["Exploratorium"]}
```

```
$ cat database
123456,{"name":"London","attractions":["Big Ben","London Eye"]}
42,{"name":"San Francisco","attractions":["Golden Gate Bridge"]}
42,{"name":"San Francisco","attractions":["Exploratorium"]}
```

Our `db_set` function actually has pretty good performance for something that is so simple, because appending to a file is generally very efficient. Similarly to what `db_set` does, many databases internally use a *log*, which is an append-only data file. Real databases have more issues to deal with (such as concurrency control, reclaiming disk space so that the log doesn't grow forever, and handling errors and partially written records), but the basic principle is the same. Logs are incredibly useful, and we will encounter them several times in the rest of this book.



The word *log* is often used to refer to application logs, where an application outputs text that describes what's happening. In this book, *log* is used in the more general sense: an append-only sequence of records. It doesn't have to be human-readable; it might be binary and intended only for other programs to read.

On the other hand, our `db_get` function has terrible performance if you have a large number of records in your database. Every time you want to look up a key, `db_get` has to scan the entire database file from beginning to end, looking for occurrences of the key. In algorithmic terms, the cost of a lookup is  $O(n)$ : if you double the number of records  $n$  in your database, a lookup takes twice as long. That's not good.

In order to efficiently find the value for a particular key in the database, we need a different data structure: an *index*. In this chapter we will look at a range of indexing structures and see how they compare; the general idea behind them is to keep some additional metadata on the side, which acts as a signpost and helps you to locate the data you want. If you want to search the same data in several different ways, you may need several different indexes on different parts of the data.

An index is an *additional* structure that is derived from the primary data. Many databases allow you to add and remove indexes, and this doesn't affect the contents of the database; it only affects the performance of queries. Maintaining additional structures incurs overhead, especially on writes. For writes, it's hard to beat the performance of simply appending to a file, because that's the simplest possible write operation. Any kind of index usually slows down writes, because the index also needs to be updated every time data is written.

This is an important trade-off in storage systems: well-chosen indexes speed up read queries, but every index slows down writes. For this reason, databases don't usually index everything by default, but require you—the application developer or database administrator—to choose indexes manually, using your knowledge of the application's typical query patterns. You can then choose the indexes that give your application the greatest benefit, without introducing more overhead than necessary.

## Hash Indexes

Let's start with indexes for key-value data. This is not the only kind of data you can index, but it's very common, and it's a useful building block for more complex indexes.

Key-value stores are quite similar to the *dictionary* type that you can find in most programming languages, and which is usually implemented as a hash map (hash table). Hash maps are described in many algorithms textbooks [1, 2], so we won't go into detail of how they work here. Since we already have hash maps for our in-memory data structures, why not use them to index our data on disk?

Let's say our data storage consists only of appending to a file, as in the preceding example. Then the simplest possible indexing strategy is this: keep an in-memory hash map where every key is mapped to a byte offset in the data file—the location at which the value can be found, as illustrated in [Figure 3-1](#). Whenever you append a new key-value pair to the file, you also update the hash map to reflect the offset of the data you just wrote (this works both for inserting new keys and for updating existing keys). When you want to look up a value, use the hash map to find the offset in the data file, seek to that location, and read the value.

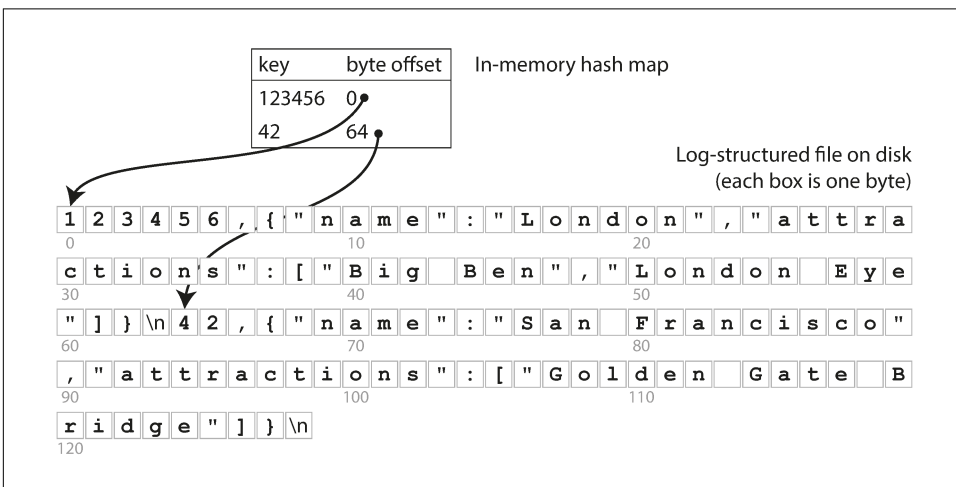

Figure 3-1. Storing a log of key-value pairs in a CSV-like format, indexed with an in-memory hash map.

This may sound simplistic, but it is a viable approach. In fact, this is essentially what Bitcask (the default storage engine in Riak) does [3]. Bitcask offers high-performance reads and writes, subject to the requirement that all the keys fit in the available RAM, since the hash map is kept completely in memory. The values can use more space than there is available memory, since they can be loaded from disk with just one disk

seek. If that part of the data file is already in the filesystem cache, a read doesn't require any disk I/O at all.

A storage engine like Bitcask is well suited to situations where the value for each key is updated frequently. For example, the key might be the URL of a cat video, and the value might be the number of times it has been played (incremented every time someone hits the play button). In this kind of workload, there are a lot of writes, but there are not too many distinct keys—you have a large number of writes per key, but it's feasible to keep all keys in memory.

As described so far, we only ever append to a file—so how do we avoid eventually running out of disk space? A good solution is to break the log into segments of a certain size by closing a segment file when it reaches a certain size, and making subsequent writes to a new segment file. We can then perform *compaction* on these segments, as illustrated in [Figure 3-2](#). Compaction means throwing away duplicate keys in the log, and keeping only the most recent update for each key.

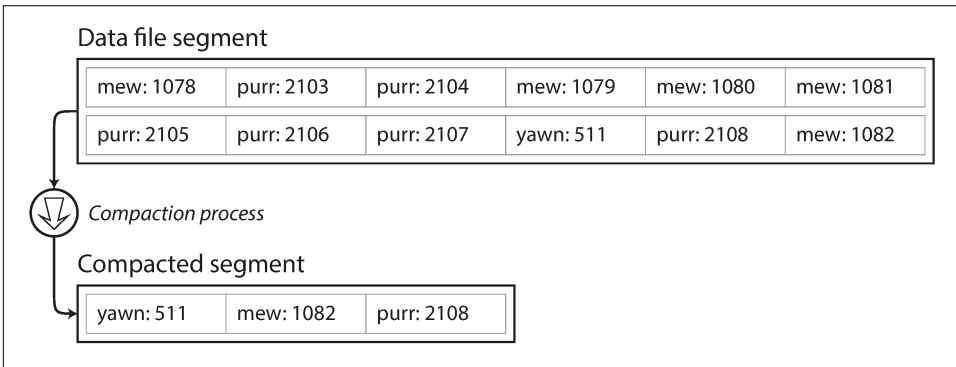

*Figure 3-2. Compaction of a key-value update log (counting the number of times each cat video was played), retaining only the most recent value for each key.*

Moreover, since compaction often makes segments much smaller (assuming that a key is overwritten several times on average within one segment), we can also merge several segments together at the same time as performing the compaction, as shown in [Figure 3-3](#). Segments are never modified after they have been written, so the merged segment is written to a new file. The merging and compaction of segments can be done in a background thread, and while it is going on, we can still continue to serve read requests using the old segment files, and write requests to the latest segment file. After the merging process is complete, we switch read requests to using the new merged segment instead of the old segments—and then the old segment files can simply be deleted.

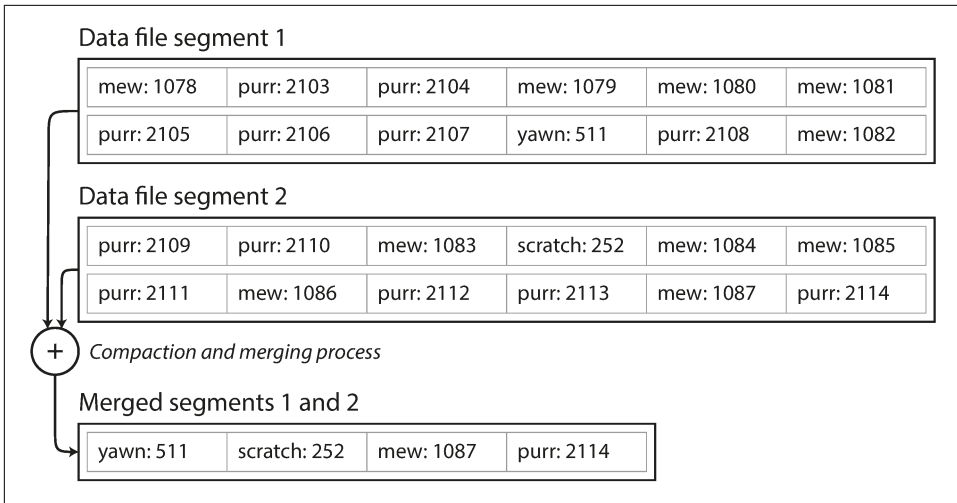

Figure 3-3. Performing compaction and segment merging simultaneously.

Each segment now has its own in-memory hash table, mapping keys to file offsets. In order to find the value for a key, we first check the most recent segment's hash map; if the key is not present we check the second-most-recent segment, and so on. The merging process keeps the number of segments small, so lookups don't need to check many hash maps.

Lots of detail goes into making this simple idea work in practice. Briefly, some of the issues that are important in a real implementation are:

#### File format

CSV is not the best format for a log. It's faster and simpler to use a binary format that first encodes the length of a string in bytes, followed by the raw string (without need for escaping).

#### Deleting records

If you want to delete a key and its associated value, you have to append a special deletion record to the data file (sometimes called a *tombstone*). When log segments are merged, the tombstone tells the merging process to discard any previous values for the deleted key.

#### Crash recovery

If the database is restarted, the in-memory hash maps are lost. In principle, you can restore each segment's hash map by reading the entire segment file from beginning to end and noting the offset of the most recent value for every key as you go along. However, that might take a long time if the segment files are large, which would make server restarts painful. Bitcask speeds up recovery by storing

a snapshot of each segment’s hash map on disk, which can be loaded into memory more quickly.

#### *Partially written records*

The database may crash at any time, including halfway through appending a record to the log. Bitcask files include checksums, allowing such corrupted parts of the log to be detected and ignored.

#### *Concurrency control*

As writes are appended to the log in a strictly sequential order, a common implementation choice is to have only one writer thread. Data file segments are append-only and otherwise immutable, so they can be read concurrently by multiple threads.

An append-only log seems wasteful at first glance: why don’t you update the file in place, overwriting the old value with the new value? But an append-only design turns out to be good for several reasons:

- Appending and segment merging are sequential write operations, which are generally much faster than random writes, especially on magnetic spinning-disk hard drives. To some extent sequential writes are also preferable on flash-based *solid state drives* (SSDs) [4]. We will discuss this issue further in “[Comparing B-Trees and LSM-Trees](#)” on page 15.
- Concurrency and crash recovery are much simpler if segment files are append-only or immutable. For example, you don’t have to worry about the case where a crash happened while a value was being overwritten, leaving you with a file containing part of the old and part of the new value spliced together.
- Merging old segments avoids the problem of data files getting fragmented over time.

However, the hash table index also has limitations:

- The hash table must fit in memory, so if you have a very large number of keys, you’re out of luck. In principle, you could maintain a hash map on disk, but unfortunately it is difficult to make an on-disk hash map perform well. It requires a lot of random access I/O, it is expensive to grow when it becomes full, and hash collisions require fiddly logic [5].
- Range queries are not efficient. For example, you cannot easily scan over all keys between `kitty00000` and `kitty99999`—you’d have to look up each key individually in the hash maps.

In the next section we will look at an indexing structure that doesn’t have those limitations.

## SSTables and LSM-Trees

In [Figure 3-3](#), each log-structured storage segment is a sequence of key-value pairs. These pairs appear in the order that they were written, and values later in the log take precedence over values for the same key earlier in the log. Apart from that, the order of key-value pairs in the file does not matter.

Now we can make a simple change to the format of our segment files: we require that the sequence of key-value pairs is *sorted by key*. We call this format *Sorted String Table*, or *SSTable* for short. With this format, we cannot append new key-value pairs to the segment immediately, since writes can occur in any order; we will see shortly how to write SSTable segments using sequential I/O.

SSTables have several big advantages over log segments with hash indexes:

1. Merging segments is simple and efficient, even if the files are bigger than the available memory. The approach is like the one used in the *mergesort* algorithm and is illustrated in [Figure 3-4](#): you start reading the input files side by side, look at the first key in each file, copy the lowest key (according to the sort order) to the output file, and repeat. This produces a new merged segment file, also sorted by key.

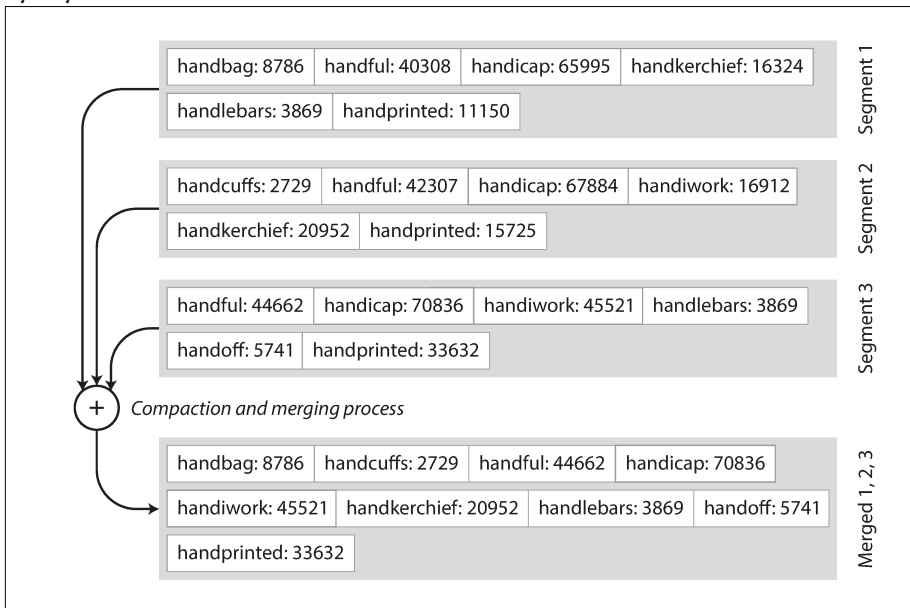

*Figure 3-4. Merging several SSTable segments, retaining only the most recent value for each key.*

What if the same key appears in several input segments? Remember that each segment contains all the values written to the database during some period of



time. This means that all the values in one input segment must be more recent than all the values in the other segment (assuming that we always merge adjacent segments). When multiple segments contain the same key, we can keep the value from the most recent segment and discard the values in older segments.

2. In order to find a particular key in the file, you no longer need to keep an index of all the keys in memory. See [Figure 3-5](#) for an example: say you're looking for the key `handiwork`, but you don't know the exact offset of that key in the segment file. However, you do know the offsets for the keys `handbag` and `handsome`, and because of the sorting you know that `handiwork` must appear between those two. This means you can jump to the offset for `handbag` and scan from there until you find `handiwork` (or not, if the key is not present in the file).

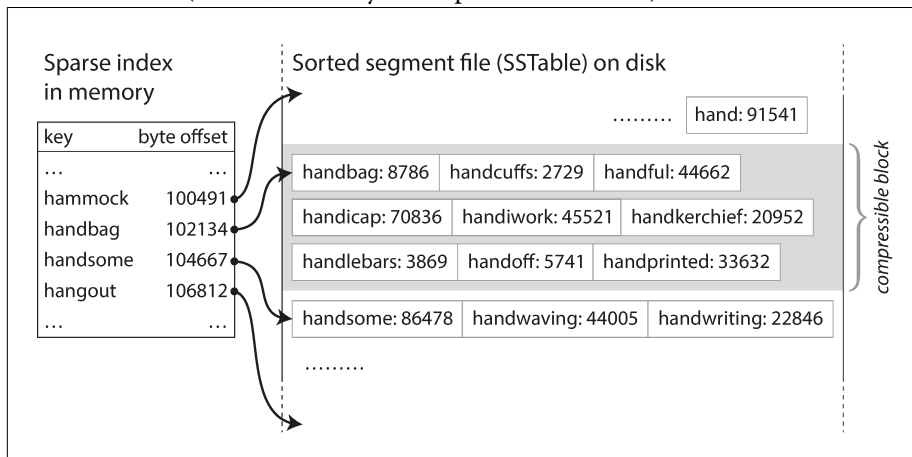

*Figure 3-5. An SSTable with an in-memory index.*

You still need an in-memory index to tell you the offsets for some of the keys, but it can be sparse: one key for every few kilobytes of segment file is sufficient, because a few kilobytes can be scanned very quickly.<sup>i</sup>

3. Since read requests need to scan over several key-value pairs in the requested range anyway, it is possible to group those records into a block and compress it before writing it to disk (indicated by the shaded area in [Figure 3-5](#)). Each entry of the sparse in-memory index then points at the start of a compressed block. Besides saving disk space, compression also reduces the I/O bandwidth use.

i. If all keys and values had a fixed size, you could use binary search on a segment file and avoid the in-memory index entirely. However, they are usually variable-length in practice, which makes it difficult to tell where one record ends and the next one starts if you don't have an index.

## Constructing and maintaining SSTables

Fine so far—but how do you get your data to be sorted by key in the first place? Our incoming writes can occur in any order.

Maintaining a sorted structure on disk is possible (see “B-Trees” on page 11), but maintaining it in memory is much easier. There are plenty of well-known tree data structures that you can use, such as red-black trees or AVL trees [2]. With these data structures, you can insert keys in any order and read them back in sorted order.

We can now make our storage engine work as follows:

- When a write comes in, add it to an in-memory balanced tree data structure (for example, a red-black tree). This in-memory tree is sometimes called a *memtable*.
- When the memtable gets bigger than some threshold—typically a few megabytes—write it out to disk as an SSTable file. This can be done efficiently because the tree already maintains the key-value pairs sorted by key. The new SSTable file becomes the most recent segment of the database. While the SSTable is being written out to disk, writes can continue to a new memtable instance.
- In order to serve a read request, first try to find the key in the memtable, then in the most recent on-disk segment, then in the next-older segment, etc.
- From time to time, run a merging and compaction process in the background to combine segment files and to discard overwritten or deleted values.

This scheme works very well. It only suffers from one problem: if the database crashes, the most recent writes (which are in the memtable but not yet written out to disk) are lost. In order to avoid that problem, we can keep a separate log on disk to which every write is immediately appended, just like in the previous section. That log is not in sorted order, but that doesn’t matter, because its only purpose is to restore the memtable after a crash. Every time the memtable is written out to an SSTable, the corresponding log can be discarded.

## Making an LSM-tree out of SSTables

The algorithm described here is essentially what is used in LevelDB [6] and RocksDB [7], key-value storage engine libraries that are designed to be embedded into other applications. Among other things, LevelDB can be used in Riak as an alternative to Bitcask. Similar storage engines are used in Cassandra and HBase [8], both of which were inspired by Google’s Bigtable paper [9] (which introduced the terms *SSTable* and *memtable*).

Originally this indexing structure was described by Patrick O’Neil et al. under the name *Log-Structured Merge-Tree* (or LSM-Tree) [10], building on earlier work on log-structured filesystems [11]. Storage engines that are based on this principle of merging and compacting sorted files are often called LSM storage engines.

Lucene, an indexing engine for full-text search used by Elasticsearch and Solr, uses a similar method for storing its *term dictionary* [12, 13]. A full-text index is much more complex than a key-value index but is based on a similar idea: given a word in a search query, find all the documents (web pages, product descriptions, etc.) that mention the word. This is implemented with a key-value structure where the key is a word (a *term*) and the value is the list of IDs of all the documents that contain the word (the *postings list*). In Lucene, this mapping from term to postings list is kept in SSTable-like sorted files, which are merged in the background as needed [14].

## Performance optimizations

As always, a lot of detail goes into making a storage engine perform well in practice. For example, the LSM-tree algorithm can be slow when looking up keys that do not exist in the database: you have to check the memtable, then the segments all the way back to the oldest (possibly having to read from disk for each one) before you can be sure that the key does not exist. In order to optimize this kind of access, storage engines often use additional *Bloom filters* [15]. (A Bloom filter is a memory-efficient data structure for approximating the contents of a set. It can tell you if a key does not appear in the database, and thus saves many unnecessary disk reads for nonexistent keys.)

There are also different strategies to determine the order and timing of how SSTables are compacted and merged. The most common options are *size-tiered* and *leveled* compaction. LevelDB and RocksDB use leveled compaction (hence the name of LevelDB), HBase uses size-tiered, and Cassandra supports both [16]. In size-tiered compaction, newer and smaller SSTables are successively merged into older and larger SSTables. In leveled compaction, the key range is split up into smaller SSTables and older data is moved into separate “levels,” which allows the compaction to proceed more incrementally and use less disk space.

Even though there are many subtleties, the basic idea of LSM-trees—keeping a cascade of SSTables that are merged in the background—is simple and effective. Even when the dataset is much bigger than the available memory it continues to work well. Since data is stored in sorted order, you can efficiently perform range queries (scanning all keys above some minimum and up to some maximum), and because the disk writes are sequential the LSM-tree can support remarkably high write throughput.

## B-Trees

The log-structured indexes we have discussed so far are gaining acceptance, but they are not the most common type of index. The most widely used indexing structure is quite different: the *B-tree*.

Introduced in 1970 [17] and called “ubiquitous” less than 10 years later [18], B-trees have stood the test of time very well. They remain the standard index implementation in almost all relational databases, and many nonrelational databases use them too.

Like SSTables, B-trees keep key-value pairs sorted by key, which allows efficient key-value lookups and range queries. But that’s where the similarity ends: B-trees have a very different design philosophy.

The log-structured indexes we saw earlier break the database down into variable-size *segments*, typically several megabytes or more in size, and always write a segment sequentially. By contrast, B-trees break the database down into fixed-size *blocks* or *pages*, traditionally 4 KB in size (sometimes bigger), and read or write one page at a time. This design corresponds more closely to the underlying hardware, as disks are also arranged in fixed-size blocks.

Each page can be identified using an address or location, which allows one page to refer to another—similar to a pointer, but on disk instead of in memory. We can use these page references to construct a tree of pages, as illustrated in [Figure 3-6](#).

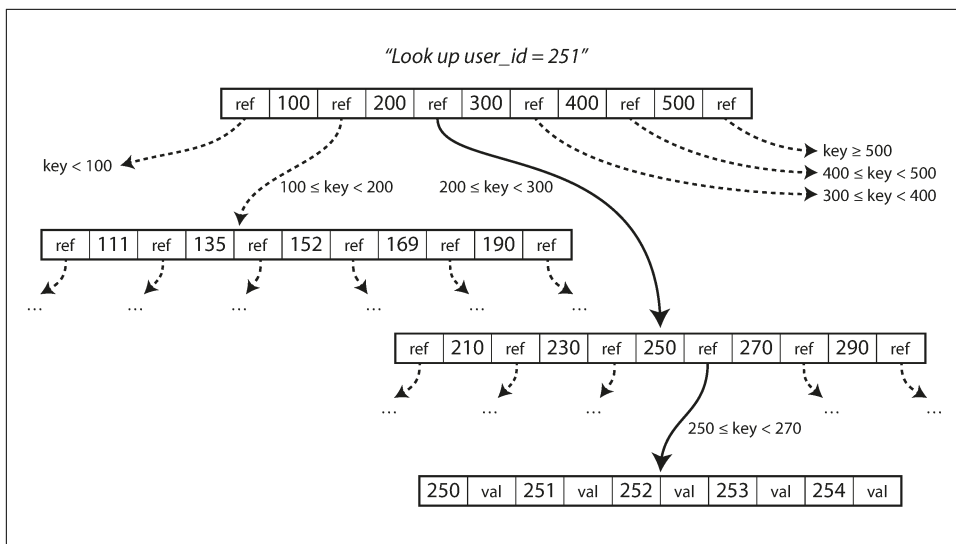

Figure 3-6. Looking up a key using a B-tree index.

One page is designated as the *root* of the B-tree; whenever you want to look up a key in the index, you start here. The page contains several keys and references to child pages. Each child is responsible for a continuous range of keys, and the keys between the references indicate where the boundaries between those ranges lie.

In the example in [Figure 3-6](#), we are looking for the key 251, so we know that we need to follow the page reference between the boundaries 200 and 300. That takes us to a similar-looking page that further breaks down the 200–300 range into subranges.

Eventually we get down to a page containing individual keys (a *leaf page*), which either contains the value for each key inline or contains references to the pages where the values can be found.

The number of references to child pages in one page of the B-tree is called the *branching factor*. For example, in [Figure 3-6](#) the branching factor is six. In practice, the branching factor depends on the amount of space required to store the page references and the range boundaries, but typically it is several hundred.

If you want to update the value for an existing key in a B-tree, you search for the leaf page containing that key, change the value in that page, and write the page back to disk (any references to that page remain valid). If you want to add a new key, you need to find the page whose range encompasses the new key and add it to that page. If there isn't enough free space in the page to accommodate the new key, it is split into two half-full pages, and the parent page is updated to account for the new subdivision of key ranges—see [Figure 3-7](#).<sup>i</sup>

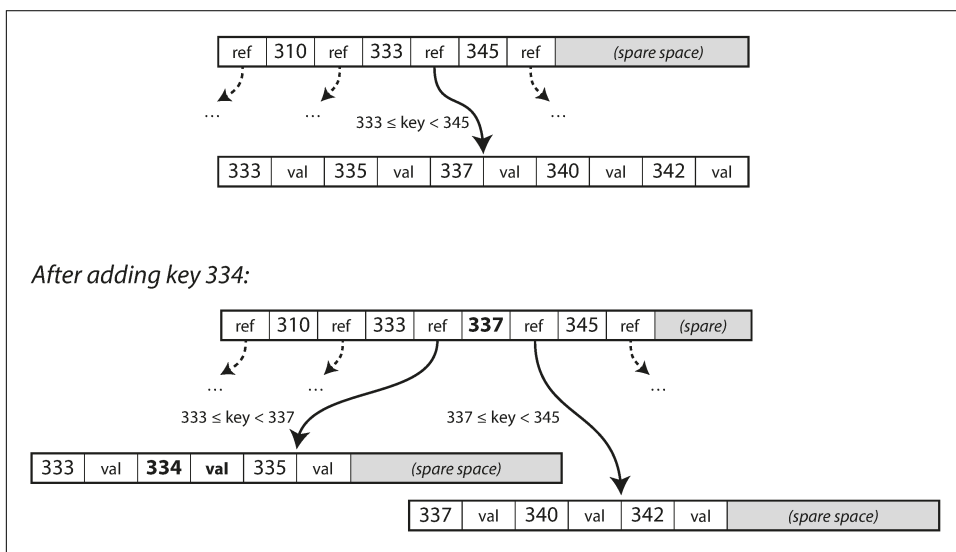

*Figure 3-7. Growing a B-tree by splitting a page.*

This algorithm ensures that the tree remains *balanced*: a B-tree with  $n$  keys always has a depth of  $O(\log n)$ . Most databases can fit into a B-tree that is three or four levels deep, so you don't need to follow many page references to find the page you are looking for. (A four-level tree of 4 KB pages with a branching factor of 500 can store up to 250 TB.)

i. Inserting a new key into a B-tree is reasonably intuitive, but deleting one (while keeping the tree balanced) is somewhat more involved [2].

## Making B-trees reliable

The basic underlying write operation of a B-tree is to overwrite a page on disk with new data. It is assumed that the overwrite does not change the location of the page; i.e., all references to that page remain intact when the page is overwritten. This is in stark contrast to log-structured indexes such as LSM-trees, which only append to files (and eventually delete obsolete files) but never modify files in place.

You can think of overwriting a page on disk as an actual hardware operation. On a magnetic hard drive, this means moving the disk head to the right place, waiting for the right position on the spinning platter to come around, and then overwriting the appropriate sector with new data. On SSDs, what happens is somewhat more complicated, due to the fact that an SSD must erase and rewrite fairly large blocks of a storage chip at a time [19].

Moreover, some operations require several different pages to be overwritten. For example, if you split a page because an insertion caused it to be overfull, you need to write the two pages that were split, and also overwrite their parent page to update the references to the two child pages. This is a dangerous operation, because if the database crashes after only some of the pages have been written, you end up with a corrupted index (e.g., there may be an *orphan* page that is not a child of any parent).

In order to make the database resilient to crashes, it is common for B-tree implementations to include an additional data structure on disk: a *write-ahead log* (WAL, also known as a *redo log*). This is an append-only file to which every B-tree modification must be written before it can be applied to the pages of the tree itself. When the database comes back up after a crash, this log is used to restore the B-tree back to a consistent state [5, 20].

An additional complication of updating pages in place is that careful concurrency control is required if multiple threads are going to access the B-tree at the same time—otherwise a thread may see the tree in an inconsistent state. This is typically done by protecting the tree’s data structures with *latches* (lightweight locks). Log-structured approaches are simpler in this regard, because they do all the merging in the background without interfering with incoming queries and atomically swap old segments for new segments from time to time.

## B-tree optimizations

As B-trees have been around for so long, it’s not surprising that many optimizations have been developed over the years. To mention just a few:

- Instead of overwriting pages and maintaining a WAL for crash recovery, some databases (like LMDB) use a copy-on-write scheme [21]. A modified page is written to a different location, and a new version of the parent pages in the tree is

created, pointing at the new location. This approach is also useful for concurrency control, as we shall see in Chapter 7.

- We can save space in pages by not storing the entire key, but abbreviating it. Especially in pages on the interior of the tree, keys only need to provide enough information to act as boundaries between key ranges. Packing more keys into a page allows the tree to have a higher branching factor, and thus fewer levels.<sup>i</sup>
- In general, pages can be positioned anywhere on disk; there is nothing requiring pages with nearby key ranges to be nearby on disk. If a query needs to scan over a large part of the key range in sorted order, that page-by-page layout can be inefficient, because a disk seek may be required for every page that is read. Many B-tree implementations therefore try to lay out the tree so that leaf pages appear in sequential order on disk. However, it's difficult to maintain that order as the tree grows. By contrast, since LSM-trees rewrite large segments of the storage in one go during merging, it's easier for them to keep sequential keys close to each other on disk.
- Additional pointers have been added to the tree. For example, each leaf page may have references to its sibling pages to the left and right, which allows scanning keys in order without jumping back to parent pages.
- B-tree variants such as *fractal trees* [22] borrow some log-structured ideas to reduce disk seeks (and they have nothing to do with fractals).

## Comparing B-Trees and LSM-Trees

Even though B-tree implementations are generally more mature than LSM-tree implementations, LSM-trees are also interesting due to their performance characteristics. As a rule of thumb, LSM-trees are typically faster for writes, whereas B-trees are thought to be faster for reads [23]. Reads are typically slower on LSM-trees because they have to check several different data structures and SSTables at different stages of compaction.

However, benchmarks are often inconclusive and sensitive to details of the workload. You need to test systems with your particular workload in order to make a valid comparison. In this section we will briefly discuss a few things that are worth considering when measuring the performance of a storage engine.

### Advantages of LSM-trees

A B-tree index must write every piece of data at least twice: once to the write-ahead log, and once to the tree page itself (and perhaps again as pages are split). There is

---

i. This variant is sometimes known as a B<sup>+</sup> tree, although the optimization is so common that it often isn't distinguished from other B-tree variants.

also overhead from having to write an entire page at a time, even if only a few bytes in that page changed. Some storage engines even overwrite the same page twice in order to avoid ending up with a partially updated page in the event of a power failure [24, 25].

Log-structured indexes also rewrite data multiple times due to repeated compaction and merging of SSTables. This effect—one write to the database resulting in multiple writes to the disk over the course of the database’s lifetime—is known as *write amplification*. It is of particular concern on SSDs, which can only overwrite blocks a limited number of times before wearing out.

In write-heavy applications, the performance bottleneck might be the rate at which the database can write to disk. In this case, write amplification has a direct performance cost: the more that a storage engine writes to disk, the fewer writes per second it can handle within the available disk bandwidth.

Moreover, LSM-trees are typically able to sustain higher write throughput than B-trees, partly because they sometimes have lower write amplification (although this depends on the storage engine configuration and workload), and partly because they sequentially write compact SSTable files rather than having to overwrite several pages in the tree [26]. This difference is particularly important on magnetic hard drives, where sequential writes are much faster than random writes.

LSM-trees can be compressed better, and thus often produce smaller files on disk than B-trees. B-tree storage engines leave some disk space unused due to fragmentation: when a page is split or when a row cannot fit into an existing page, some space in a page remains unused. Since LSM-trees are not page-oriented and periodically rewrite SSTables to remove fragmentation, they have lower storage overheads, especially when using leveled compaction [27].

On many SSDs, the firmware internally uses a log-structured algorithm to turn random writes into sequential writes on the underlying storage chips, so the impact of the storage engine’s write pattern is less pronounced [19]. However, lower write amplification and reduced fragmentation are still advantageous on SSDs: representing data more compactly allows more read and write requests within the available I/O bandwidth.

### **Downsides of LSM-trees**

A downside of log-structured storage is that the compaction process can sometimes interfere with the performance of ongoing reads and writes. Even though storage engines try to perform compaction incrementally and without affecting concurrent access, disks have limited resources, so it can easily happen that a request needs to wait while the disk finishes an expensive compaction operation. The impact on throughput and average response time is usually small, but at higher percentiles (see



Chapter 1) the response time of queries to log-structured storage engines can sometimes be quite high, and B-trees can be more predictable [28].

Another issue with compaction arises at high write throughput: the disk's finite write bandwidth needs to be shared between the initial write (logging and flushing a memtable to disk) and the compaction threads running in the background. When writing to an empty database, the full disk bandwidth can be used for the initial write, but the bigger the database gets, the more disk bandwidth is required for compaction.

If write throughput is high and compaction is not configured carefully, it can happen that compaction cannot keep up with the rate of incoming writes. In this case, the number of unmerged segments on disk keeps growing until you run out of disk space, and reads also slow down because they need to check more segment files. Typically, SSTable-based storage engines do not throttle the rate of incoming writes, even if compaction cannot keep up, so you need explicit monitoring to detect this situation [29, 30].

An advantage of B-trees is that each key exists in exactly one place in the index, whereas a log-structured storage engine may have multiple copies of the same key in different segments. This aspect makes B-trees attractive in databases that want to offer strong transactional semantics: in many relational databases, transaction isolation is implemented using locks on ranges of keys, and in a B-tree index, those locks can be directly attached to the tree [5]. In Chapter 7 we will discuss this point in more detail.

B-trees are very ingrained in the architecture of databases and provide consistently good performance for many workloads, so it's unlikely that they will go away anytime soon. In new datastores, log-structured indexes are becoming increasingly popular. There is no quick and easy rule for determining which type of storage engine is better for your use case, so it is worth testing empirically.

## Other Indexing Structures

So far we have only discussed key-value indexes, which are like a *primary key* index in the relational model. A primary key uniquely identifies one row in a relational table, or one document in a document database, or one vertex in a graph database. Other records in the database can refer to that row/document/vertex by its primary key (or ID), and the index is used to resolve such references.

It is also very common to have *secondary indexes*. In relational databases, you can create several secondary indexes on the same table using the `CREATE INDEX` command, and they are often crucial for performing joins efficiently. For example, in Figure 2-1 in Chapter 2 you would most likely have a secondary index on the `user_id` columns so that you can find all the rows belonging to the same user in each of the tables.

A secondary index can easily be constructed from a key-value index. The main difference is that in a secondary index, the indexed values are not necessarily unique; that is, there might be many rows (documents, vertices) under the same index entry. This can be solved in two ways: either by making each value in the index a list of matching row identifiers (like a postings list in a full-text index) or by making each entry unique by appending a row identifier to it. Either way, both B-trees and log-structured indexes can be used as secondary indexes.

### Storing values within the index

The key in an index is the thing that queries search for, but the value can be one of two things: it could be the actual row (document, vertex) in question, or it could be a reference to the row stored elsewhere. In the latter case, the place where rows are stored is known as a *heap file*, and it stores data in no particular order (it may be append-only, or it may keep track of deleted rows in order to overwrite them with new data later). The heap file approach is common because it avoids duplicating data when multiple secondary indexes are present: each index just references a location in the heap file, and the actual data is kept in one place.

When updating a value without changing the key, the heap file approach can be quite efficient: the record can be overwritten in place, provided that the new value is not larger than the old value. The situation is more complicated if the new value is larger, as it probably needs to be moved to a new location in the heap where there is enough space. In that case, either all indexes need to be updated to point at the new heap location of the record, or a forwarding pointer is left behind in the old heap location [5].

In some situations, the extra hop from the index to the heap file is too much of a performance penalty for reads, so it can be desirable to store the indexed row directly within an index. This is known as a *clustered index*. For example, in MySQL's InnoDB storage engine, the primary key of a table is always a clustered index, and secondary indexes refer to the primary key (rather than a heap file location) [31]. In SQL Server, you can specify one clustered index per table [32].

A compromise between a clustered index (storing all row data within the index) and a nonclustered index (storing only references to the data within the index) is known as a *covering index* or *index with included columns*, which stores *some* of a table's columns within the index [33]. This allows some queries to be answered by using the index alone (in which case, the index is said to *cover* the query) [32].

As with any kind of duplication of data, clustered and covering indexes can speed up reads, but they require additional storage and can add overhead on writes. Databases also need to go to additional effort to enforce transactional guarantees, because applications should not see inconsistencies due to the duplication.

## Multi-column indexes

The indexes discussed so far only map a single key to a value. That is not sufficient if we need to query multiple columns of a table (or multiple fields in a document) simultaneously.

The most common type of multi-column index is called a *concatenated index*, which simply combines several fields into one key by appending one column to another (the index definition specifies in which order the fields are concatenated). This is like an old-fashioned paper phone book, which provides an index from (*lastname, first-name*) to phone number. Due to the sort order, the index can be used to find all the people with a particular last name, or all the people with a particular *lastname-firstname* combination. However, the index is useless if you want to find all the people with a particular first name.

Multi-dimensional indexes are a more general way of querying several columns at once, which is particularly important for geospatial data. For example, a restaurant-search website may have a database containing the latitude and longitude of each restaurant. When a user is looking at the restaurants on a map, the website needs to search for all the restaurants within the rectangular map area that the user is currently viewing. This requires a two-dimensional range query like the following:

```
SELECT * FROM restaurants WHERE latitude > 51.4946 AND latitude < 51.5079
AND longitude > -0.1162 AND longitude < -0.1004;
```

A standard B-tree or LSM-tree index is not able to answer that kind of query efficiently: it can give you either all the restaurants in a range of latitudes (but at any longitude), or all the restaurants in a range of longitudes (but anywhere between the North and South poles), but not both simultaneously.

One option is to translate a two-dimensional location into a single number using a space-filling curve, and then to use a regular B-tree index [34]. More commonly, specialized spatial indexes such as R-trees are used. For example, PostGIS implements geospatial indexes as R-trees using PostgreSQL's Generalized Search Tree indexing facility [35]. We don't have space to describe R-trees in detail here, but there is plenty of literature on them.

An interesting idea is that multi-dimensional indexes are not just for geographic locations. For example, on an ecommerce website you could use a three-dimensional index on the dimensions (*red, green, blue*) to search for products in a certain range of colors, or in a database of weather observations you could have a two-dimensional index on (*date, temperature*) in order to efficiently search for all the observations during the year 2013 where the temperature was between 25 and 30°C. With a one-dimensional index, you would have to either scan over all the records from 2013 (regardless of temperature) and then filter them by temperature, or vice versa. A 2D

index could narrow down by timestamp and temperature simultaneously. This technique is used by HyperDex [36].

### Full-text search and fuzzy indexes

All the indexes discussed so far assume that you have exact data and allow you to query for exact values of a key, or a range of values of a key with a sort order. What they don't allow you to do is search for *similar* keys, such as misspelled words. Such *fuzzy* querying requires different techniques.

For example, full-text search engines commonly allow a search for one word to be expanded to include synonyms of the word, to ignore grammatical variations of words, and to search for occurrences of words near each other in the same document, and support various other features that depend on linguistic analysis of the text. To cope with typos in documents or queries, Lucene is able to search text for words within a certain edit distance (an edit distance of 1 means that one letter has been added, removed, or replaced) [37].

As mentioned in “[Making an LSM-tree out of SSTables](#)” on page 10, Lucene uses a SSTable-like structure for its term dictionary. This structure requires a small in-memory index that tells queries at which offset in the sorted file they need to look for a key. In LevelDB, this in-memory index is a sparse collection of some of the keys, but in Lucene, the in-memory index is a finite state automaton over the characters in the keys, similar to a *trie* [38]. This automaton can be transformed into a *Levenshtein automaton*, which supports efficient search for words within a given edit distance [39].

Other fuzzy search techniques go in the direction of document classification and machine learning. See an information retrieval textbook for more detail [e.g., 40].

### Keeping everything in memory

The data structures discussed so far in this chapter have all been answers to the limitations of disks. Compared to main memory, disks are awkward to deal with. With both magnetic disks and SSDs, data on disk needs to be laid out carefully if you want good performance on reads and writes. However, we tolerate this awkwardness because disks have two significant advantages: they are durable (their contents are not lost if the power is turned off), and they have a lower cost per gigabyte than RAM.

As RAM becomes cheaper, the cost-per-gigabyte argument is eroded. Many datasets are simply not that big, so it's quite feasible to keep them entirely in memory, potentially distributed across several machines. This has led to the development of *in-memory databases*.

Some in-memory key-value stores, such as Memcached, are intended for caching use only, where it's acceptable for data to be lost if a machine is restarted. But other in-memory databases aim for durability, which can be achieved with special hardware (such as battery-powered RAM), by writing a log of changes to disk, by writing periodic snapshots to disk, or by replicating the in-memory state to other machines.

When an in-memory database is restarted, it needs to reload its state, either from disk or over the network from a replica (unless special hardware is used). Despite writing to disk, it's still an in-memory database, because the disk is merely used as an append-only log for durability, and reads are served entirely from memory. Writing to disk also has operational advantages: files on disk can easily be backed up, inspected, and analyzed by external utilities.

Products such as VoltDB, MemSQL, and Oracle TimesTen are in-memory databases with a relational model, and the vendors claim that they can offer big performance improvements by removing all the overheads associated with managing on-disk data structures [41, 42]. RAMCloud is an open source, in-memory key-value store with durability (using a log-structured approach for the data in memory as well as the data on disk) [43]. Redis and Couchbase provide weak durability by writing to disk asynchronously.

Counterintuitively, the performance advantage of in-memory databases is not due to the fact that they don't need to read from disk. Even a disk-based storage engine may never need to read from disk if you have enough memory, because the operating system caches recently used disk blocks in memory anyway. Rather, they can be faster because they can avoid the overheads of encoding in-memory data structures in a form that can be written to disk [44].

Besides performance, another interesting area for in-memory databases is providing data models that are difficult to implement with disk-based indexes. For example, Redis offers a database-like interface to various data structures such as priority queues and sets. Because it keeps all data in memory, its implementation is comparatively simple.

Recent research indicates that an in-memory database architecture could be extended to support datasets larger than the available memory, without bringing back the overheads of a disk-centric architecture [45]. The so-called *anti-caching* approach works by evicting the least recently used data from memory to disk when there is not enough memory, and loading it back into memory when it is accessed again in the future. This is similar to what operating systems do with virtual memory and swap files, but the database can manage memory more efficiently than the OS, as it can work at the granularity of individual records rather than entire memory pages. This approach still requires indexes to fit entirely in memory, though (like the Bitcask example at the beginning of the chapter).

Further changes to storage engine design will probably be needed if *non-volatile memory* (NVM) technologies become more widely adopted [46]. At present, this is a new area of research, but it is worth keeping an eye on in the future.

## Transaction Processing or Analytics?

In the early days of business data processing, a write to the database typically corresponded to a *commercial transaction* taking place: making a sale, placing an order with a supplier, paying an employee’s salary, etc. As databases expanded into areas that didn’t involve money changing hands, the term *transaction* nevertheless stuck, referring to a group of reads and writes that form a logical unit.



A transaction needn’t necessarily have ACID (atomicity, consistency, isolation, and durability) properties. *Transaction processing* just means allowing clients to make low-latency reads and writes—as opposed to *batch processing* jobs, which only run periodically (for example, once per day). We discuss the ACID properties in Chapter 7 and batch processing in Chapter 10.

Even though databases started being used for many different kinds of data—comments on blog posts, actions in a game, contacts in an address book, etc.—the basic access pattern remained similar to processing business transactions. An application typically looks up a small number of records by some key, using an index. Records are inserted or updated based on the user’s input. Because these applications are interactive, the access pattern became known as *online transaction processing* (OLTP).

However, databases also started being increasingly used for *data analytics*, which has very different access patterns. Usually an analytic query needs to scan over a huge number of records, only reading a few columns per record, and calculates aggregate statistics (such as count, sum, or average) rather than returning the raw data to the user. For example, if your data is a table of sales transactions, then analytic queries might be:

- What was the total revenue of each of our stores in January?
- How many more bananas than usual did we sell during our latest promotion?
- Which brand of baby food is most often purchased together with brand X diapers?

These queries are often written by business analysts, and feed into reports that help the management of a company make better decisions (*business intelligence*). In order to differentiate this pattern of using databases from transaction processing, it has

been called *online analytic processing* (OLAP) [47].<sup>i</sup> The difference between OLTP and OLAP is not always clear-cut, but some typical characteristics are listed in [Table 3-1](#).

*Table 3-1. Comparing characteristics of transaction processing versus analytic systems*

Property	Transaction processing systems (OLTP)	Analytic systems (OLAP)
Main read pattern	Small number of records per query, fetched by key	Aggregate over large number of records
Main write pattern	Random-access, low-latency writes from user input	Bulk import (ETL) or event stream
Primarily used by	End user/customer, via web application	Internal analyst, for decision support
What data represents	Latest state of data (current point in time)	History of events that happened over time
Dataset size	Gigabytes to terabytes	Terabytes to petabytes

At first, the same databases were used for both transaction processing and analytic queries. SQL turned out to be quite flexible in this regard: it works well for OLTP-type queries as well as OLAP-type queries. Nevertheless, in the late 1980s and early 1990s, there was a trend for companies to stop using their OLTP systems for analytics purposes, and to run the analytics on a separate database instead. This separate database was called a *data warehouse*.

## Data Warehousing

An enterprise may have dozens of different transaction processing systems: systems powering the customer-facing website, controlling point of sale (checkout) systems in physical stores, tracking inventory in warehouses, planning routes for vehicles, managing suppliers, administering employees, etc. Each of these systems is complex and needs a team of people to maintain it, so the systems end up operating mostly autonomously from each other.

These OLTP systems are usually expected to be highly available and to process transactions with low latency, since they are often critical to the operation of the business. Database administrators therefore closely guard their OLTP databases. They are usually reluctant to let business analysts run ad hoc analytic queries on an OLTP database, since those queries are often expensive, scanning large parts of the dataset, which can harm the performance of concurrently executing transactions.

A *data warehouse*, by contrast, is a separate database that analysts can query to their hearts' content, without affecting OLTP operations [48]. The data warehouse contains a read-only copy of the data in all the various OLTP systems in the company. Data is extracted from OLTP databases (using either a periodic data dump or a con-

---

i. The meaning of *online* in OLAP is unclear; it probably refers to the fact that queries are not just for predefined reports, but that analysts use the OLAP system interactively for explorative queries.

tinuous stream of updates), transformed into an analysis-friendly schema, cleaned up, and then loaded into the data warehouse. This process of getting data into the warehouse is known as *Extract-Transform-Load* (ETL) and is illustrated in [Figure 3-8](#).

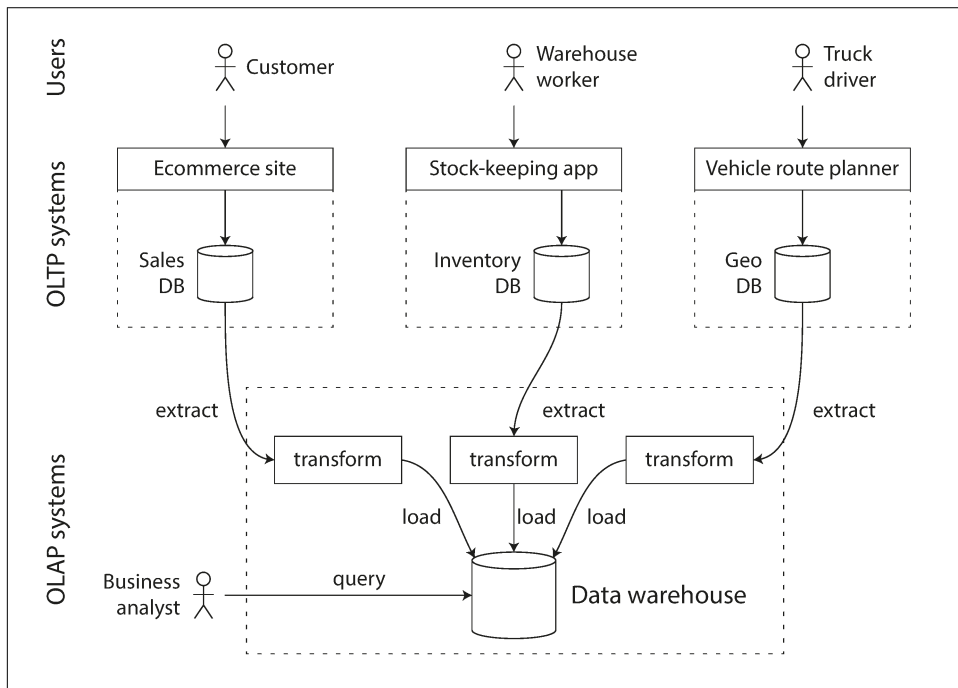

Figure 3-8. Simplified outline of ETL into a data warehouse.

Data warehouses now exist in almost all large enterprises, but in small companies they are almost unheard of. This is probably because most small companies don't have so many different OLTP systems, and most small companies have a small amount of data—small enough that it can be queried in a conventional SQL database, or even analyzed in a spreadsheet. In a large company, a lot of heavy lifting is required to do something that is simple in a small company.

A big advantage of using a separate data warehouse, rather than querying OLTP systems directly for analytics, is that the data warehouse can be optimized for analytic access patterns. It turns out that the indexing algorithms discussed in the first half of this chapter work well for OLTP, but are not very good at answering analytic queries. In the rest of this chapter we will look at storage engines that are optimized for analytics instead.



## The divergence between OLTP databases and data warehouses

The data model of a data warehouse is most commonly relational, because SQL is generally a good fit for analytic queries. There are many graphical data analysis tools that generate SQL queries, visualize the results, and allow analysts to explore the data (through operations such as *drill-down* and *slicing and dicing*).

On the surface, a data warehouse and a relational OLTP database look similar, because they both have a SQL query interface. However, the internals of the systems can look quite different, because they are optimized for very different query patterns. Many database vendors now focus on supporting either transaction processing or analytics workloads, but not both.

Some databases, such as Microsoft SQL Server and SAP HANA, have support for transaction processing and data warehousing in the same product. However, they are increasingly becoming two separate storage and query engines, which happen to be accessible through a common SQL interface [49, 50, 51].

Data warehouse vendors such as Teradata, Vertica, SAP HANA, and ParAccel typically sell their systems under expensive commercial licenses. Amazon RedShift is a hosted version of ParAccel. More recently, a plethora of open source SQL-on-Hadoop projects have emerged; they are young but aiming to compete with commercial data warehouse systems. These include Apache Hive, Spark SQL, Cloudera Impala, Facebook Presto, Apache Tajo, and Apache Drill [52, 53]. Some of them are based on ideas from Google's Dremel [54].

## Stars and Snowflakes: Schemas for Analytics

As explored in Chapter 2, a wide range of different data models are used in the realm of transaction processing, depending on the needs of the application. On the other hand, in analytics, there is much less diversity of data models. Many data warehouses are used in a fairly formulaic style, known as a *star schema* (also known as *dimensional modeling* [55]).

The example schema in [Figure 3-9](#) shows a data warehouse that might be found at a grocery retailer. At the center of the schema is a so-called *fact table* (in this example, it is called `fact_sales`). Each row of the fact table represents an event that occurred at a particular time (here, each row represents a customer's purchase of a product). If we were analyzing website traffic rather than retail sales, each row might represent a page view or a click by a user.

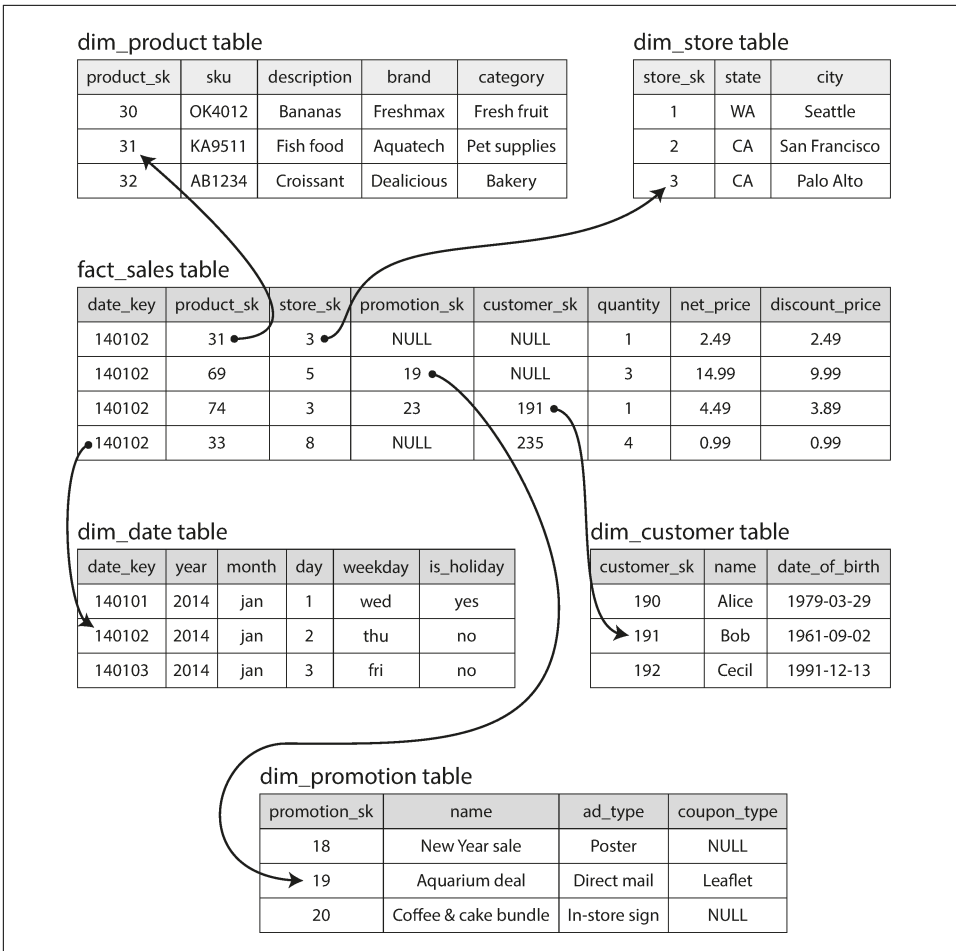

Figure 3-9. Example of a star schema for use in a data warehouse.

Usually, facts are captured as individual events, because this allows maximum flexibility of analysis later. However, this means that the fact table can become extremely large. A big enterprise like Apple, Walmart, or eBay may have tens of petabytes of transaction history in its data warehouse, most of which is in fact tables [56].

Some of the columns in the fact table are attributes, such as the price at which the product was sold and the cost of buying it from the supplier (allowing the profit margin to be calculated). Other columns in the fact table are foreign key references to other tables, called *dimension tables*. As each row in the fact table represents an event, the dimensions represent the *who*, *what*, *where*, *when*, *how*, and *why* of the event.

For example, in Figure 3-9, one of the dimensions is the product that was sold. Each row in the dim\_product table represents one type of product that is for sale, including

its stock-keeping unit (SKU), description, brand name, category, fat content, package size, etc. Each row in the `fact_sales` table uses a foreign key to indicate which product was sold in that particular transaction. (For simplicity, if the customer buys several different products at once, they are represented as separate rows in the fact table.)

Even date and time are often represented using dimension tables, because this allows additional information about dates (such as public holidays) to be encoded, allowing queries to differentiate between sales on holidays and non-holidays.

The name “star schema” comes from the fact that when the table relationships are visualized, the fact table is in the middle, surrounded by its dimension tables; the connections to these tables are like the rays of a star.

A variation of this template is known as the *snowflake schema*, where dimensions are further broken down into subdimensions. For example, there could be separate tables for brands and product categories, and each row in the `dim_product` table could reference the brand and category as foreign keys, rather than storing them as strings in the `dim_product` table. Snowflake schemas are more normalized than star schemas, but star schemas are often preferred because they are simpler for analysts to work with [55].

In a typical data warehouse, tables are often very wide: fact tables often have over 100 columns, sometimes several hundred [51]. Dimension tables can also be very wide, as they include all the metadata that may be relevant for analysis—for example, the `dim_store` table may include details of which services are offered at each store, whether it has an in-store bakery, the square footage, the date when the store was first opened, when it was last remodeled, how far it is from the nearest highway, etc.

## Column-Oriented Storage

If you have trillions of rows and petabytes of data in your fact tables, storing and querying them efficiently becomes a challenging problem. Dimension tables are usually much smaller (millions of rows), so in this section we will concentrate primarily on storage of facts.

Although fact tables are often over 100 columns wide, a typical data warehouse query only accesses 4 or 5 of them at one time (“SELECT \*” queries are rarely needed for analytics) [51]. Take the query in [Example 3-1](#): it accesses a large number of rows (every occurrence of someone buying fruit or candy during the 2013 calendar year), but it only needs to access three columns of the `fact_sales` table: `date_key`, `product_sk`, and `quantity`. The query ignores all other columns.

Example 3-1. Analyzing whether people are more inclined to buy fresh fruit or candy, depending on the day of the week

```
SELECT
  dim_date.weekday, dim_product.category,
  SUM(fact_sales.quantity) AS quantity_sold
FROM fact_sales
  JOIN dim_date   ON fact_sales.date_key   = dim_date.date_key
  JOIN dim_product ON fact_sales.product_sk = dim_product.product_sk
WHERE
  dim_date.year = 2013 AND
  dim_product.category IN ('Fresh fruit', 'Candy')
GROUP BY
  dim_date.weekday, dim_product.category;
```

How can we execute this query efficiently?

In most OLTP databases, storage is laid out in a *row-oriented* fashion: all the values from one row of a table are stored next to each other. Document databases are similar: an entire document is typically stored as one contiguous sequence of bytes. You can see this in the CSV example of [Figure 3-1](#).

In order to process a query like [Example 3-1](#), you may have indexes on `fact_sales.date_key` and/or `fact_sales.product_sk` that tell the storage engine where to find all the sales for a particular date or for a particular product. But then, a row-oriented storage engine still needs to load all of those rows (each consisting of over 100 attributes) from disk into memory, parse them, and filter out those that don't meet the required conditions. That can take a long time.

The idea behind *column-oriented storage* is simple: don't store all the values from one row together, but store all the values from each *column* together instead. If each column is stored in a separate file, a query only needs to read and parse those columns that are used in that query, which can save a lot of work. This principle is illustrated in [Figure 3-10](#).



Column storage is easiest to understand in a relational data model, but it applies equally to nonrelational data. For example, Parquet [57] is a columnar storage format that supports a document data model, based on Google's Dremel [54].

fact_sales table							
date_key	product_sk	store_sk	promotion_sk	customer_sk	quantity	net_price	discount_price
140102	69	4	NULL	NULL	1	13.99	13.99
140102	69	5	19	NULL	3	14.99	9.99
140102	69	5	NULL	191	1	14.99	14.99
140102	74	3	23	202	5	0.99	0.89
140103	31	2	NULL	NULL	1	2.49	2.49
140103	31	3	NULL	NULL	3	14.99	9.99
140103	31	3	21	123	1	49.99	39.99
140103	31	8	NULL	233	1	0.99	0.99

**Columnar storage layout:**

date\_key file contents: 140102, 140102, 140102, 140102, 140103, 140103, 140103, 140103

product\_sk file contents: 69, 69, 69, 74, 31, 31, 31, 31

store\_sk file contents: 4, 5, 5, 3, 2, 3, 3, 8

promotion\_sk file contents: NULL, 19, NULL, 23, NULL, NULL, 21, NULL

customer\_sk file contents: NULL, NULL, 191, 202, NULL, NULL, 123, 233

quantity file contents: 1, 3, 1, 5, 1, 3, 1, 1

net\_price file contents: 13.99, 14.99, 14.99, 0.99, 2.49, 14.99, 49.99, 0.99

discount\_price file contents: 13.99, 9.99, 14.99, 0.89, 2.49, 9.99, 39.99, 0.99

Figure 3-10. Storing relational data by column, rather than by row.

The column-oriented storage layout relies on each column file containing the rows in the same order. Thus, if you need to reassemble an entire row, you can take the 23rd entry from each of the individual column files and put them together to form the 23rd row of the table.

## Column Compression

Besides only loading those columns from disk that are required for a query, we can further reduce the demands on disk throughput by compressing data. Fortunately, column-oriented storage often lends itself very well to compression.

Take a look at the sequences of values for each column in [Figure 3-10](#): they often look quite repetitive, which is a good sign for compression. Depending on the data in the column, different compression techniques can be used. One technique that is particularly effective in data warehouses is *bitmap encoding*, illustrated in [Figure 3-11](#).

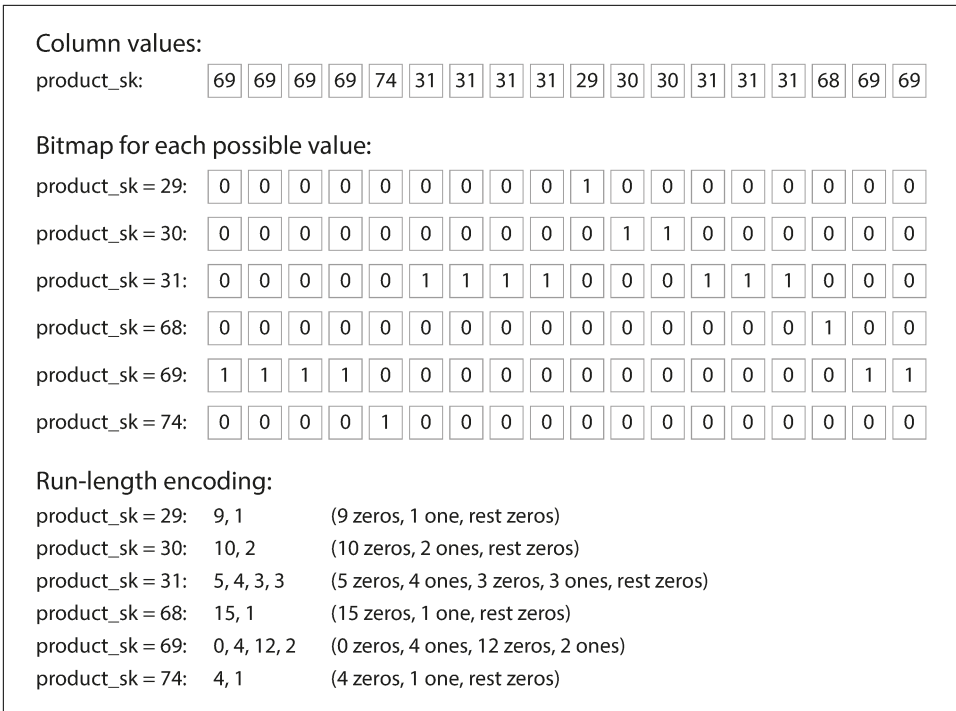

Figure 3-11. Compressed, bitmap-indexed storage of a single column.

Often, the number of distinct values in a column is small compared to the number of rows (for example, a retailer may have billions of sales transactions, but only 100,000 distinct products). We can now take a column with  $n$  distinct values and turn it into  $n$  separate bitmaps: one bitmap for each distinct value, with one bit for each row. The bit is 1 if the row has that value, and 0 if not.

If  $n$  is very small (for example, a *country* column may have approximately 200 distinct values), those bitmaps can be stored with one bit per row. But if  $n$  is bigger, there will be a lot of zeros in most of the bitmaps (we say that they are *sparse*). In that case, the bitmaps can additionally be run-length encoded, as shown at the bottom of [Figure 3-11](#). This can make the encoding of a column remarkably compact.

Bitmap indexes such as these are very well suited for the kinds of queries that are common in a data warehouse. For example:

```
WHERE product_sk IN (30, 68, 69):
```

Load the three bitmaps for `product_sk = 30`, `product_sk = 68`, and `product_sk = 69`, and calculate the bitwise *OR* of the three bitmaps, which can be done very efficiently.

WHERE product\_sk = 31 AND store\_sk = 3:

Load the bitmaps for product\_sk = 31 and store\_sk = 3, and calculate the bitwise *AND*. This works because the columns contain the rows in the same order, so the *k*th bit in one column's bitmap corresponds to the same row as the *k*th bit in another column's bitmap.

There are also various other compression schemes for different kinds of data, but we won't go into them in detail—see [58] for an overview.



### Column-oriented storage and column families

Cassandra and HBase have a concept of *column families*, which they inherited from Bigtable [9]. However, it is very misleading to call them column-oriented: within each column family, they store all columns from a row together, along with a row key, and they do not use column compression. Thus, the Bigtable model is still mostly row-oriented.

### Memory bandwidth and vectorized processing

For data warehouse queries that need to scan over millions of rows, a big bottleneck is the bandwidth for getting data from disk into memory. However, that is not the only bottleneck. Developers of analytical databases also worry about efficiently using the bandwidth from main memory into the CPU cache, avoiding branch mispredictions and bubbles in the CPU instruction processing pipeline, and making use of single-instruction-multi-data (SIMD) instructions in modern CPUs [59, 60].

Besides reducing the volume of data that needs to be loaded from disk, column-oriented storage layouts are also good for making efficient use of CPU cycles. For example, the query engine can take a chunk of compressed column data that fits comfortably in the CPU's L1 cache and iterate through it in a tight loop (that is, with no function calls). A CPU can execute such a loop much faster than code that requires a lot of function calls and conditions for each record that is processed. Column compression allows more rows from a column to fit in the same amount of L1 cache. Operators, such as the bitwise *AND* and *OR* described previously, can be designed to operate on such chunks of compressed column data directly. This technique is known as *vectorized processing* [58, 49].

### Sort Order in Column Storage

In a column store, it doesn't necessarily matter in which order the rows are stored. It's easiest to store them in the order in which they were inserted, since then inserting a new row just means appending to each of the column files. However, we can choose to impose an order, like we did with SSTables previously, and use that as an indexing mechanism.

Note that it wouldn't make sense to sort each column independently, because then we would no longer know which items in the columns belong to the same row. We can only reconstruct a row because we know that the  $k$ th item in one column belongs to the same row as the  $k$ th item in another column.

Rather, the data needs to be sorted an entire row at a time, even though it is stored by column. The administrator of the database can choose the columns by which the table should be sorted, using their knowledge of common queries. For example, if queries often target date ranges, such as the last month, it might make sense to make `date_key` the first sort key. Then the query optimizer can scan only the rows from the last month, which will be much faster than scanning all rows.

A second column can determine the sort order of any rows that have the same value in the first column. For example, if `date_key` is the first sort key in [Figure 3-10](#), it might make sense for `product_sk` to be the second sort key so that all sales for the same product on the same day are grouped together in storage. That will help queries that need to group or filter sales by product within a certain date range.

Another advantage of sorted order is that it can help with compression of columns. If the primary sort column does not have many distinct values, then after sorting, it will have long sequences where the same value is repeated many times in a row. A simple run-length encoding, like we used for the bitmaps in [Figure 3-11](#), could compress that column down to a few kilobytes—even if the table has billions of rows.

That compression effect is strongest on the first sort key. The second and third sort keys will be more jumbled up, and thus not have such long runs of repeated values. Columns further down the sorting priority appear in essentially random order, so they probably won't compress as well. But having the first few columns sorted is still a win overall.

### Several different sort orders

A clever extension of this idea was introduced in C-Store and adopted in the commercial data warehouse Vertica [61, 62]. Different queries benefit from different sort orders, so why not store the same data sorted in *several different* ways? Data needs to be replicated to multiple machines anyway, so that you don't lose data if one machine fails. You might as well store that redundant data sorted in different ways so that when you're processing a query, you can use the version that best fits the query pattern.

Having multiple sort orders in a column-oriented store is a bit similar to having multiple secondary indexes in a row-oriented store. But the big difference is that the row-oriented store keeps every row in one place (in the heap file or a clustered index), and secondary indexes just contain pointers to the matching rows. In a column store, there normally aren't any pointers to data elsewhere, only columns containing values.



## Writing to Column-Oriented Storage

These optimizations make sense in data warehouses, because most of the load consists of large read-only queries run by analysts. Column-oriented storage, compression, and sorting all help to make those read queries faster. However, they have the downside of making writes more difficult.

An update-in-place approach, like B-trees use, is not possible with compressed columns. If you wanted to insert a row in the middle of a sorted table, you would most likely have to rewrite all the column files. As rows are identified by their position within a column, the insertion has to update all columns consistently.

Fortunately, we have already seen a good solution earlier in this chapter: LSM-trees. All writes first go to an in-memory store, where they are added to a sorted structure and prepared for writing to disk. It doesn't matter whether the in-memory store is row-oriented or column-oriented. When enough writes have accumulated, they are merged with the column files on disk and written to new files in bulk. This is essentially what Vertica does [62].

Queries need to examine both the column data on disk and the recent writes in memory, and combine the two. However, the query optimizer hides this distinction from the user. From an analyst's point of view, data that has been modified with inserts, updates, or deletes is immediately reflected in subsequent queries.

## Aggregation: Data Cubes and Materialized Views

Not every data warehouse is necessarily a column store: traditional row-oriented databases and a few other architectures are also used. However, columnar storage can be significantly faster for ad hoc analytical queries, so it is rapidly gaining popularity [51, 63].

Another aspect of data warehouses that is worth mentioning briefly is *materialized aggregates*. As discussed earlier, data warehouse queries often involve an aggregate function, such as COUNT, SUM, AVG, MIN, or MAX in SQL. If the same aggregates are used by many different queries, it can be wasteful to crunch through the raw data every time. Why not cache some of the counts or sums that queries use most often?

One way of creating such a cache is a *materialized view*. In a relational data model, it is often defined like a standard (virtual) view: a table-like object whose contents are the results of some query. The difference is that a materialized view is an actual copy of the query results, written to disk, whereas a virtual view is just a shortcut for writing queries. When you read from a virtual view, the SQL engine expands it into the view's underlying query on the fly and then processes the expanded query.

When the underlying data changes, a materialized view needs to be updated, because it is a denormalized copy of the data. The database can do that automatically, but

such updates make writes more expensive, which is why materialized views are not often used in OLTP databases. In read-heavy data warehouses they can make more sense (whether or not they actually improve read performance depends on the individual case).

A common special case of a materialized view is known as a *data cube* or *OLAP cube* [64]. It is a grid of aggregates grouped by different dimensions. Figure 3-12 shows an example.

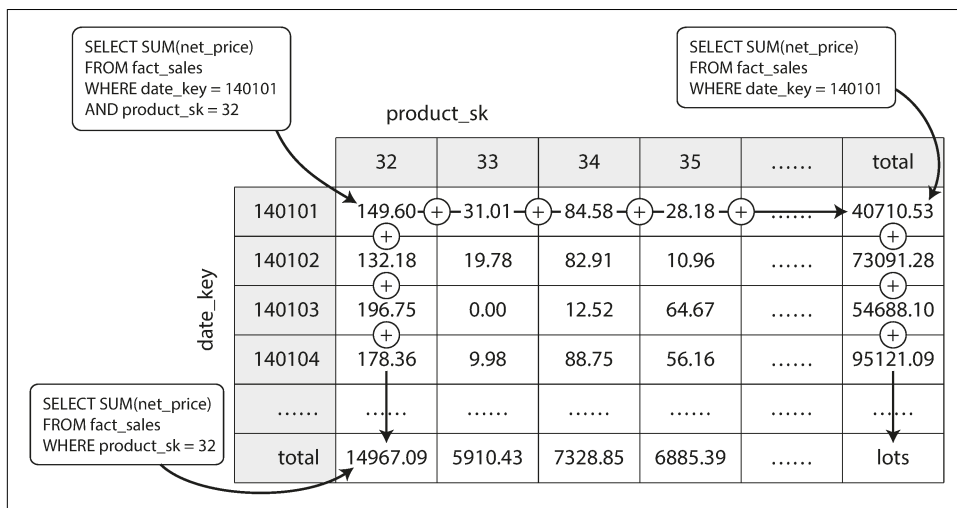

Figure 3-12. Two dimensions of a data cube, aggregating data by summing.

Imagine for now that each fact has foreign keys to only two dimension tables—in Figure 3-12, these are *date* and *product*. You can now draw a two-dimensional table, with dates along one axis and products along the other. Each cell contains the aggregate (e.g., SUM) of an attribute (e.g., *net\_price*) of all facts with that date-product combination. Then you can apply the same aggregate along each row or column and get a summary that has been reduced by one dimension (the sales by product regardless of date, or the sales by date regardless of product).

In general, facts often have more than two dimensions. In Figure 3-9 there are five dimensions: date, product, store, promotion, and customer. It's a lot harder to imagine what a five-dimensional hypercube would look like, but the principle remains the same: each cell contains the sales for a particular date-product-store-promotion-customer combination. These values can then repeatedly be summarized along each of the dimensions.

The advantage of a materialized data cube is that certain queries become very fast because they have effectively been precomputed. For example, if you want to know

the total sales per store yesterday, you just need to look at the totals along the appropriate dimension—no need to scan millions of rows.

The disadvantage is that a data cube doesn't have the same flexibility as querying the raw data. For example, there is no way of calculating which proportion of sales comes from items that cost more than \$100, because the price isn't one of the dimensions. Most data warehouses therefore try to keep as much raw data as possible, and use aggregates such as data cubes only as a performance boost for certain queries.

## Summary

In this chapter we tried to get to the bottom of how databases handle storage and retrieval. What happens when you store data in a database, and what does the database do when you query for the data again later?

On a high level, we saw that storage engines fall into two broad categories: those optimized for transaction processing (OLTP), and those optimized for analytics (OLAP). There are big differences between the access patterns in those use cases:

- OLTP systems are typically user-facing, which means that they may see a huge volume of requests. In order to handle the load, applications usually only touch a small number of records in each query. The application requests records using some kind of key, and the storage engine uses an index to find the data for the requested key. Disk seek time is often the bottleneck here.
- Data warehouses and similar analytic systems are less well known, because they are primarily used by business analysts, not by end users. They handle a much lower volume of queries than OLTP systems, but each query is typically very demanding, requiring many millions of records to be scanned in a short time. Disk bandwidth (not seek time) is often the bottleneck here, and column-oriented storage is an increasingly popular solution for this kind of workload.

On the OLTP side, we saw storage engines from two main schools of thought:

- The log-structured school, which only permits appending to files and deleting obsolete files, but never updates a file that has been written. Bitcask, SSTables, LSM-trees, LevelDB, Cassandra, HBase, Lucene, and others belong to this group.
- The update-in-place school, which treats the disk as a set of fixed-size pages that can be overwritten. B-trees are the biggest example of this philosophy, being used in all major relational databases and also many nonrelational ones.

Log-structured storage engines are a comparatively recent development. Their key idea is that they systematically turn random-access writes into sequential writes on disk, which enables higher write throughput due to the performance characteristics of hard drives and SSDs.

Finishing off the OLTP side, we did a brief tour through some more complicated indexing structures, and databases that are optimized for keeping all data in memory.

We then took a detour from the internals of storage engines to look at the high-level architecture of a typical data warehouse. This background illustrated why analytic workloads are so different from OLTP: when your queries require sequentially scanning across a large number of rows, indexes are much less relevant. Instead it becomes important to encode data very compactly, to minimize the amount of data that the query needs to read from disk. We discussed how column-oriented storage helps achieve this goal.

As an application developer, if you're armed with this knowledge about the internals of storage engines, you are in a much better position to know which tool is best suited for your particular application. If you need to adjust a database's tuning parameters, this understanding allows you to imagine what effect a higher or a lower value may have.

Although this chapter couldn't make you an expert in tuning any one particular storage engine, it has hopefully equipped you with enough vocabulary and ideas that you can make sense of the documentation for the database of your choice.

---

## References

- [1] Alfred V. Aho, John E. Hopcroft, and Jeffrey D. Ullman: *Data Structures and Algorithms*. Addison-Wesley, 1983. ISBN: 978-0-201-00023-8
- [2] Thomas H. Cormen, Charles E. Leiserson, Ronald L. Rivest, and Clifford Stein: *Introduction to Algorithms*, 3rd edition. MIT Press, 2009. ISBN: 978-0-262-53305-8
- [3] Justin Sheehy and David Smith: “[Bitcask: A Log-Structured Hash Table for Fast Key/Value Data](#),” Basho Technologies, April 2010.
- [4] Yanan Li, Bingsheng He, Robin Jun Yang, et al.: “[Tree Indexing on Solid State Drives](#),” *Proceedings of the VLDB Endowment*, volume 3, number 1, pages 1195–1206, September 2010.
- [5] Goetz Graefe: “[Modern B-Tree Techniques](#),” *Foundations and Trends in Databases*, volume 3, number 4, pages 203–402, August 2011. doi:10.1561/19000000028
- [6] Jeffrey Dean and Sanjay Ghemawat: “[LevelDB Implementation Notes](#),” *github.com*.
- [7] Dhruba Borthakur: “[The History of RocksDB](#),” *rocksdb.blogspot.com*, November 24, 2013.
- [8] Matteo Bertozzi: “[Apache HBase I/O – HFile](#),” *blog.cloudera.com*, June 29, 2012.

- [9] Fay Chang, Jeffrey Dean, Sanjay Ghemawat, et al.: “[Bigtable: A Distributed Storage System for Structured Data](#),” at *7th USENIX Symposium on Operating System Design and Implementation (OSDI)*, November 2006.
- [10] Patrick O’Neil, Edward Cheng, Dieter Gawlick, and Elizabeth O’Neil: “[The Log-Structured Merge-Tree \(LSM-Tree\)](#),” *Acta Informatica*, volume 33, number 4, pages 351–385, June 1996. doi:10.1007/s002360050048
- [11] Mendel Rosenblum and John K. Ousterhout: “[The Design and Implementation of a Log-Structured File System](#),” *ACM Transactions on Computer Systems*, volume 10, number 1, pages 26–52, February 1992. doi:10.1145/146941.146943
- [12] Adrien Grand: “[What Is in a Lucene Index?](#),” at *Lucene/Solr Revolution*, November 14, 2013.
- [13] Deepak Kandepet: “[Hacking Lucene—The Index Format](#),” *hackerlabs.github.io*, October 1, 2011.
- [14] Michael McCandless: “[Visualizing Lucene’s Segment Merges](#),” *blog.mikemccandless.com*, February 11, 2011.
- [15] Burton H. Bloom: “[Space/Time Trade-offs in Hash Coding with Allowable Errors](#),” *Communications of the ACM*, volume 13, number 7, pages 422–426, July 1970. doi:10.1145/362686.362692
- [16] “[Operating Cassandra: Compaction](#),” Apache Cassandra Documentation v4.0, 2016.
- [17] Rudolf Bayer and Edward M. McCreight: “[Organization and Maintenance of Large Ordered Indices](#),” Boeing Scientific Research Laboratories, Mathematical and Information Sciences Laboratory, report no. 20, July 1970.
- [18] Douglas Comer: “[The Ubiquitous B-Tree](#),” *ACM Computing Surveys*, volume 11, number 2, pages 121–137, June 1979. doi:10.1145/356770.356776
- [19] Emmanuel Goossaert: “[Coding for SSDs](#),” *codecapsule.com*, February 12, 2014.
- [20] C. Mohan and Frank Levine: “[ARIES/IM: An Efficient and High Concurrency Index Management Method Using Write-Ahead Logging](#),” at *ACM International Conference on Management of Data (SIGMOD)*, June 1992. doi:10.1145/130283.130338
- [21] Howard Chu: “[LDAP at Lightning Speed](#),” at *Build Stuff’14*, November 2014.
- [22] Bradley C. Kuzmaul: “[A Comparison of Fractal Trees to Log-Structured Merge \(LSM\) Trees](#),” *tokutek.com*, April 22, 2014.
- [23] Manos Athanassoulis, Michael S. Kester, Lukas M. Maas, et al.: “[Designing Access Methods: The RUM Conjecture](#),” at *19th International Conference on Extending Database Technology (EDBT)*, March 2016. doi:10.5441/002/edbt.2016.42

- [24] Peter Zaitsev: “[Innodb Double Write](#),” *percona.com*, August 4, 2006.
- [25] Tomas Vondra: “[On the Impact of Full-Page Writes](#),” *blog.2ndquadrant.com*, November 23, 2016.
- [26] Mark Callaghan: “[The Advantages of an LSM vs a B-Tree](#),” *smalldatum.blogspot.co.uk*, January 19, 2016.
- [27] Mark Callaghan: “[Choosing Between Efficiency and Performance with RocksDB](#),” at *Code Mesh*, November 4, 2016.
- [28] Michi Mutsuzaki: “MySQL vs. LevelDB” [URL inactive], August 2011.
- [29] Benjamin Coverston, Jonathan Ellis, et al.: “[CASSANDRA-1608: Redesigning Compaction](#),” *issues.apache.org*, July 2011.
- [30] Igor Canadi, Siying Dong, and Mark Callaghan: “[RocksDB Tuning Guide](#),” *github.com*, 2016.
- [31] *MySQL 5.7 Reference Manual*. Oracle, 2014.
- [32] *Books Online for SQL Server 2012*. Microsoft, 2012.
- [33] Joe Webb: “[Using Covering Indexes to Improve Query Performance](#),” *simple-talk.com*, 29 September 2008.
- [34] Frank Ramsak, Volker Markl, Robert Fenk, et al.: “[Integrating the UB-Tree into a Database System Kernel](#),” at *26th International Conference on Very Large Data Bases (VLDB)*, September 2000.
- [35] The PostGIS Development Group: “[PostGIS 2.1.2dev Manual](#),” *postgis.net*, 2014.
- [36] Robert Escriva, Bernard Wong, and Emin Gün Sirer: “[HyperDex: A Distributed, Searchable Key-Value Store](#),” at *ACM SIGCOMM Conference*, August 2012. doi:10.1145/2377677.2377681
- [37] Michael McCandless: “[Lucene’s FuzzyQuery Is 100 Times Faster in 4.0](#),” *blog.mikemccandless.com*, March 24, 2011.
- [38] Steffen Heinz, Justin Zobel, and Hugh E. Williams: “[Burst Tries: A Fast, Efficient Data Structure for String Keys](#),” *ACM Transactions on Information Systems*, volume 20, number 2, pages 192–223, April 2002. doi:10.1145/506309.506312
- [39] Klaus U. Schulz and Stoyan Mihov: “[Fast String Correction with Levenshtein Automata](#),” *International Journal on Document Analysis and Recognition*, volume 5, number 1, pages 67–85, November 2002. doi:10.1007/s10032-002-0082-8
- [40] Christopher D. Manning, Prabhakar Raghavan, and Hinrich Schütze: *Introduction to Information Retrieval*. Cambridge University Press, 2008. ISBN: 978-0-521-86571-5, available online at [nlp.stanford.edu/IR-book](http://nlp.stanford.edu/IR-book)

- [41] Michael Stonebraker, Samuel Madden, Daniel J. Abadi, et al.: “[The End of an Architectural Era \(It’s Time for a Complete Rewrite\)](#),” at *33rd International Conference on Very Large Data Bases (VLDB)*, September 2007.
- [42] “[VoltDB Technical Overview White Paper](#),” VoltDB, 2014.
- [43] Stephen M. Rumble, Ankita Kejriwal, and John K. Ousterhout: “[Log-Structured Memory for DRAM-Based Storage](#),” at *12th USENIX Conference on File and Storage Technologies (FAST)*, February 2014.
- [44] Stavros Harizopoulos, Daniel J. Abadi, Samuel Madden, and Michael Stonebraker: “[OLTP Through the Looking Glass, and What We Found There](#),” at *ACM International Conference on Management of Data (SIGMOD)*, June 2008. doi: [10.1145/1376616.1376713](https://doi.org/10.1145/1376616.1376713)
- [45] Justin DeBrabant, Andrew Pavlo, Stephen Tu, et al.: “[Anti-Caching: A New Approach to Database Management System Architecture](#),” *Proceedings of the VLDB Endowment*, volume 6, number 14, pages 1942–1953, September 2013.
- [46] Joy Arulraj, Andrew Pavlo, and Subramanya R. Dulloor: “[Let’s Talk About Storage & Recovery Methods for Non-Volatile Memory Database Systems](#),” at *ACM International Conference on Management of Data (SIGMOD)*, June 2015. doi: [10.1145/2723372.2749441](https://doi.org/10.1145/2723372.2749441)
- [47] Edgar F. Codd, S. B. Codd, and C. T. Salley: “[Providing OLAP to User-Analysts: An IT Mandate](#),” E. F. Codd Associates, 1993.
- [48] Surajit Chaudhuri and Umeshwar Dayal: “[An Overview of Data Warehousing and OLAP Technology](#),” *ACM SIGMOD Record*, volume 26, number 1, pages 65–74, March 1997. doi:[10.1145/248603.248616](https://doi.org/10.1145/248603.248616)
- [49] Per-Åke Larson, Cipri Clinciu, Campbell Fraser, et al.: “[Enhancements to SQL Server Column Stores](#),” at *ACM International Conference on Management of Data (SIGMOD)*, June 2013.
- [50] Franz Färber, Norman May, Wolfgang Lehner, et al.: “[The SAP HANA Database – An Architecture Overview](#),” *IEEE Data Engineering Bulletin*, volume 35, number 1, pages 28–33, March 2012.
- [51] Michael Stonebraker: “[The Traditional RDBMS Wisdom Is \(Almost Certainly\) All Wrong](#),” presentation at *EPFL*, May 2013.
- [52] Daniel J. Abadi: “[Classifying the SQL-on-Hadoop Solutions](#),” *hadapt.com*, October 2, 2013.
- [53] Marcel Kornacker, Alexander Behm, Victor Bittorf, et al.: “[Impala: A Modern, Open-Source SQL Engine for Hadoop](#),” at *7th Biennial Conference on Innovative Data Systems Research (CIDR)*, January 2015.

- [54] Sergey Melnik, Andrey Gubarev, Jing Jing Long, et al.: “**Dremel: Interactive Analysis of Web-Scale Datasets**,” at *36th International Conference on Very Large Data Bases (VLDB)*, pages 330–339, September 2010.
- [55] Ralph Kimball and Margy Ross: *The Data Warehouse Toolkit: The Definitive Guide to Dimensional Modeling*, 3rd edition. John Wiley & Sons, July 2013. ISBN: 978-1-118-53080-1
- [56] Derrick Harris: “**Why Apple, eBay, and Walmart Have Some of the Biggest Data Warehouses You’ve Ever Seen**,” *gigaom.com*, March 27, 2013.
- [57] Julien Le Dem: “**Dremel Made Simple with Parquet**,” *blog.twitter.com*, September 11, 2013.
- [58] Daniel J. Abadi, Peter Boncz, Stavros Harizopoulos, et al.: “**The Design and Implementation of Modern Column-Oriented Database Systems**,” *Foundations and Trends in Databases*, volume 5, number 3, pages 197–280, December 2013. doi:10.1561/19000000024
- [59] Peter Boncz, Marcin Zukowski, and Niels Nes: “**MonetDB/X100: Hyper-Pipelining Query Execution**,” at *2nd Biennial Conference on Innovative Data Systems Research (CIDR)*, January 2005.
- [60] Jingren Zhou and Kenneth A. Ross: “**Implementing Database Operations Using SIMD Instructions**,” at *ACM International Conference on Management of Data (SIGMOD)*, pages 145–156, June 2002. doi:10.1145/564691.564709
- [61] Michael Stonebraker, Daniel J. Abadi, Adam Batkin, et al.: “**C-Store: A Column-oriented DBMS**,” at *31st International Conference on Very Large Data Bases (VLDB)*, pages 553–564, September 2005.
- [62] Andrew Lamb, Matt Fuller, Ramakrishna Varadarajan, et al.: “**The Vertica Analytic Database: C-Store 7 Years Later**,” *Proceedings of the VLDB Endowment*, volume 5, number 12, pages 1790–1801, August 2012.
- [63] Julien Le Dem and Nong Li: “**Efficient Data Storage for Analytics with Apache Parquet 2.0**,” at *Hadoop Summit*, San Jose, June 2014.
- [64] Jim Gray, Surajit Chaudhuri, Adam Bosworth, et al.: “**Data Cube: A Relational Aggregation Operator Generalizing Group-By, Cross-Tab, and Sub-Totals**,” *Data Mining and Knowledge Discovery*, volume 1, number 1, pages 29–53, March 2007. doi:10.1023/A:1009726021843







To Consistency & Consensus (Chapter 9)

To Log-structured Storage (Chapter 3)

LOGICAL COAST

PHYSICAL COAST

FOREST OF CONSISTENCY MODELS

PIT OF FAILOVER

BAY OF CAUSALITY

QUORUM HARBOR

PINNACLES OF CONFLICT RESOLUTION

MULTI-LEADER REPLICATION

REPLICATION LAG HIGHWAY

LEADERLESS REPLICATION

EVENTUAL CONSISTENCY BOULEVARD

RethinkDB

MongoDB

MySQL

Oracle

PostgreSQL

SQL Server

Etherpad

Google Docs

CouchDB

Calendar sync

CRDTs

Riak

Voldemort

Cassandra

---

# Replication

*The major difference between a thing that might go wrong and a thing that cannot possibly go wrong is that when a thing that cannot possibly go wrong goes wrong it usually turns out to be impossible to get at or repair.*

—Douglas Adams, *Mostly Harmless* (1992)

*Replication* means keeping a copy of the same data on multiple machines that are connected via a network. As discussed in the introduction to Part II, there are several reasons why you might want to replicate data:

- To keep data geographically close to your users (and thus reduce access latency)
- To allow the system to continue working even if some of its parts have failed (and thus increase availability)
- To scale out the number of machines that can serve read queries (and thus increase read throughput)

In this chapter we will assume that your dataset is so small that each machine can hold a copy of the entire dataset. In Chapter 6 we will relax that assumption and discuss *partitioning* (*sharding*) of datasets that are too big for a single machine. In later chapters we will discuss various kinds of faults that can occur in a replicated data system, and how to deal with them.

If the data that you're replicating does not change over time, then replication is easy: you just need to copy the data to every node once, and you're done. All of the difficulty in replication lies in handling *changes* to replicated data, and that's what this chapter is about. We will discuss three popular algorithms for replicating changes between nodes: *single-leader*, *multi-leader*, and *leaderless* replication. Almost all distributed databases use one of these three approaches. They all have various pros and cons, which we will examine in detail.

There are many trade-offs to consider with replication: for example, whether to use synchronous or asynchronous replication, and how to handle failed replicas. Those are often configuration options in databases, and although the details vary by database, the general principles are similar across many different implementations. We will discuss the consequences of such choices in this chapter.

Replication of databases is an old topic—the principles haven’t changed much since they were studied in the 1970s [1], because the fundamental constraints of networks have remained the same. However, outside of research, many developers continued to assume for a long time that a database consisted of just one node. Mainstream use of distributed databases is more recent. Since many application developers are new to this area, there has been a lot of misunderstanding around issues such as *eventual consistency*. In “[Problems with Replication Lag](#)” on page 53 we will get more precise about eventual consistency and discuss things like the *read-your-writes* and *monotonic reads* guarantees.

## Leaders and Followers

Each node that stores a copy of the database is called a *replica*. With multiple replicas, a question inevitably arises: how do we ensure that all the data ends up on all the replicas?

Every write to the database needs to be processed by every replica; otherwise, the replicas would no longer contain the same data. The most common solution for this is called *leader-based replication* (also known as *active/passive* or *master–slave replication*) and is illustrated in [Figure 5-1](#). It works as follows:

1. One of the replicas is designated the *leader* (also known as *master* or *primary*). When clients want to write to the database, they must send their requests to the leader, which first writes the new data to its local storage.
2. The other replicas are known as *followers* (*read replicas*, *slaves*, *secondaries*, or *hot standbys*).<sup>i</sup> Whenever the leader writes new data to its local storage, it also sends the data change to all of its followers as part of a *replication log* or *change stream*. Each follower takes the log from the leader and updates its local copy of the database accordingly, by applying all writes in the same order as they were processed on the leader.

---

i. Different people have different definitions for *hot*, *warm*, and *cold* standby servers. In PostgreSQL, for example, *hot standby* is used to refer to a replica that accepts reads from clients, whereas a *warm standby* processes changes from the leader but doesn’t process any queries from clients. For purposes of this book, the difference isn’t important.

- When a client wants to read from the database, it can query either the leader or any of the followers. However, writes are only accepted on the leader (the followers are read-only from the client's point of view).

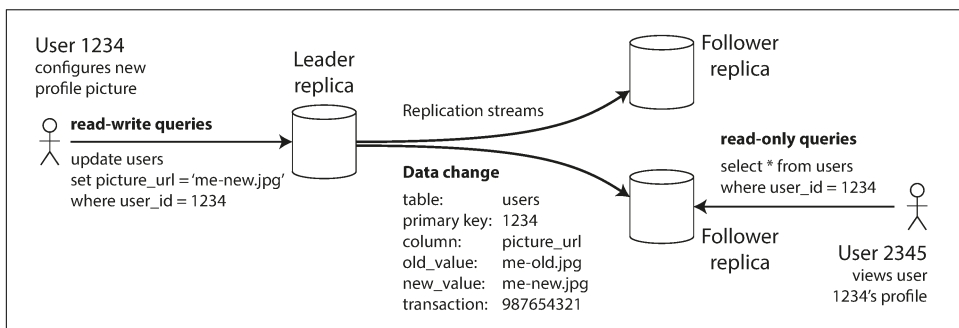

Figure 5-1. Leader-based (master-slave) replication.

This mode of replication is a built-in feature of many relational databases, such as PostgreSQL (since version 9.0), MySQL, Oracle Data Guard [2], and SQL Server's AlwaysOn Availability Groups [3]. It is also used in some nonrelational databases, including MongoDB, RethinkDB, and Espresso [4]. Finally, leader-based replication is not restricted to only databases: distributed message brokers such as Kafka [5] and RabbitMQ highly available queues [6] also use it. Some network filesystems and replicated block devices such as DRBD are similar.

## Synchronous Versus Asynchronous Replication

An important detail of a replicated system is whether the replication happens *synchronously* or *asynchronously*. (In relational databases, this is often a configurable option; other systems are often hardcoded to be either one or the other.)

Think about what happens in Figure 5-1, where the user of a website updates their profile image. At some point in time, the client sends the update request to the leader; shortly afterward, it is received by the leader. At some point, the leader forwards the data change to the followers. Eventually, the leader notifies the client that the update was successful.

Figure 5-2 shows the communication between various components of the system: the user's client, the leader, and two followers. Time flows from left to right. A request or response message is shown as a thick arrow.

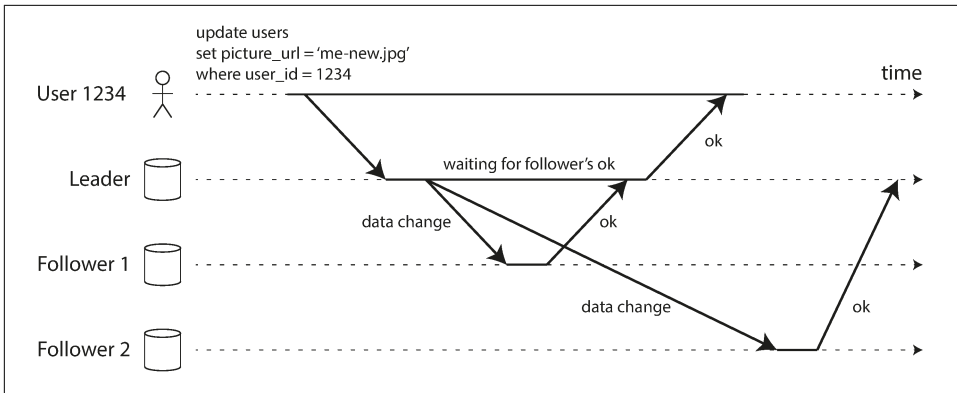

Figure 5-2. Leader-based replication with one synchronous and one asynchronous follower.

In the example of [Figure 5-2](#), the replication to follower 1 is *synchronous*: the leader waits until follower 1 has confirmed that it received the write before reporting success to the user, and before making the write visible to other clients. The replication to follower 2 is *asynchronous*: the leader sends the message, but doesn't wait for a response from the follower.

The diagram shows that there is a substantial delay before follower 2 processes the message. Normally, replication is quite fast: most database systems apply changes to followers in less than a second. However, there is no guarantee of how long it might take. There are circumstances when followers might fall behind the leader by several minutes or more; for example, if a follower is recovering from a failure, if the system is operating near maximum capacity, or if there are network problems between the nodes.

The advantage of synchronous replication is that the follower is guaranteed to have an up-to-date copy of the data that is consistent with the leader. If the leader suddenly fails, we can be sure that the data is still available on the follower. The disadvantage is that if the synchronous follower doesn't respond (because it has crashed, or there is a network fault, or for any other reason), the write cannot be processed. The leader must block all writes and wait until the synchronous replica is available again.

For that reason, it is impracticable for all followers to be synchronous: any one node outage would cause the whole system to grind to a halt. In practice, if you enable synchronous replication on a database, it usually means that *one* of the followers is synchronous, and the others are asynchronous. If the synchronous follower becomes unavailable or slow, one of the asynchronous followers is made synchronous. This guarantees that you have an up-to-date copy of the data on at least two nodes: the

leader and one synchronous follower. This configuration is sometimes also called *semi-synchronous* [7].

Often, leader-based replication is configured to be completely asynchronous. In this case, if the leader fails and is not recoverable, any writes that have not yet been replicated to followers are lost. This means that a write is not guaranteed to be durable, even if it has been confirmed to the client. However, a fully asynchronous configuration has the advantage that the leader can continue processing writes, even if all of its followers have fallen behind.

Weakening durability may sound like a bad trade-off, but asynchronous replication is nevertheless widely used, especially if there are many followers or if they are geographically distributed. We will return to this issue in “[Problems with Replication Lag](#)” on page 53.

### Research on Replication

It can be a serious problem for asynchronously replicated systems to lose data if the leader fails, so researchers have continued investigating replication methods that do not lose data but still provide good performance and availability. For example, *chain replication* [8, 9] is a variant of synchronous replication that has been successfully implemented in a few systems such as Microsoft Azure Storage [10, 11].

There is a strong connection between consistency of replication and *consensus* (getting several nodes to agree on a value), and we will explore this area of theory in more detail in Chapter 9. In this chapter we will concentrate on the simpler forms of replication that are most commonly used in databases in practice.

## Setting Up New Followers

From time to time, you need to set up new followers—perhaps to increase the number of replicas, or to replace failed nodes. How do you ensure that the new follower has an accurate copy of the leader’s data?

Simply copying data files from one node to another is typically not sufficient: clients are constantly writing to the database, and the data is always in flux, so a standard file copy would see different parts of the database at different points in time. The result might not make any sense.

You could make the files on disk consistent by locking the database (making it unavailable for writes), but that would go against our goal of high availability. Fortunately, setting up a follower can usually be done without downtime. Conceptually, the process looks like this:

1. Take a consistent snapshot of the leader's database at some point in time—if possible, without taking a lock on the entire database. Most databases have this feature, as it is also required for backups. In some cases, third-party tools are needed, such as *innobackupex* for MySQL [12].
2. Copy the snapshot to the new follower node.
3. The follower connects to the leader and requests all the data changes that have happened since the snapshot was taken. This requires that the snapshot is associated with an exact position in the leader's replication log. That position has various names: for example, PostgreSQL calls it the *log sequence number*, and MySQL calls it the *binlog coordinates*.
4. When the follower has processed the backlog of data changes since the snapshot, we say it has *caught up*. It can now continue to process data changes from the leader as they happen.

The practical steps of setting up a follower vary significantly by database. In some systems the process is fully automated, whereas in others it can be a somewhat arcane multi-step workflow that needs to be manually performed by an administrator.

## Handling Node Outages

Any node in the system can go down, perhaps unexpectedly due to a fault, but just as likely due to planned maintenance (for example, rebooting a machine to install a kernel security patch). Being able to reboot individual nodes without downtime is a big advantage for operations and maintenance. Thus, our goal is to keep the system as a whole running despite individual node failures, and to keep the impact of a node outage as small as possible.

How do you achieve high availability with leader-based replication?

### Follower failure: Catch-up recovery

On its local disk, each follower keeps a log of the data changes it has received from the leader. If a follower crashes and is restarted, or if the network between the leader and the follower is temporarily interrupted, the follower can recover quite easily: from its log, it knows the last transaction that was processed before the fault occurred. Thus, the follower can connect to the leader and request all the data changes that occurred during the time when the follower was disconnected. When it has applied these changes, it has caught up to the leader and can continue receiving a stream of data changes as before.



## Leader failure: Failover

Handling a failure of the leader is trickier: one of the followers needs to be promoted to be the new leader, clients need to be reconfigured to send their writes to the new leader, and the other followers need to start consuming data changes from the new leader. This process is called *failover*.

Failover can happen manually (an administrator is notified that the leader has failed and takes the necessary steps to make a new leader) or automatically. An automatic failover process usually consists of the following steps:

1. *Determining that the leader has failed.* There are many things that could potentially go wrong: crashes, power outages, network issues, and more. There is no foolproof way of detecting what has gone wrong, so most systems simply use a timeout: nodes frequently bounce messages back and forth between each other, and if a node doesn't respond for some period of time—say, 30 seconds—it is assumed to be dead. (If the leader is deliberately taken down for planned maintenance, this doesn't apply.)
2. *Choosing a new leader.* This could be done through an election process (where the leader is chosen by a majority of the remaining replicas), or a new leader could be appointed by a previously elected *controller node*. The best candidate for leadership is usually the replica with the most up-to-date data changes from the old leader (to minimize any data loss). Getting all the nodes to agree on a new leader is a consensus problem, discussed in detail in Chapter 9.
3. *Reconfiguring the system to use the new leader.* Clients now need to send their write requests to the new leader (we discuss this in Chapter 6). If the old leader comes back, it might still believe that it is the leader, not realizing that the other replicas have forced it to step down. The system needs to ensure that the old leader becomes a follower and recognizes the new leader.

Failover is fraught with things that can go wrong:

- If asynchronous replication is used, the new leader may not have received all the writes from the old leader before it failed. If the former leader rejoins the cluster after a new leader has been chosen, what should happen to those writes? The new leader may have received conflicting writes in the meantime. The most common solution is for the old leader's unreplicated writes to simply be discarded, which may violate clients' durability expectations.
- Discarding writes is especially dangerous if other storage systems outside of the database need to be coordinated with the database contents. For example, in one incident at GitHub [13], an out-of-date MySQL follower was promoted to leader. The database used an autoincrementing counter to assign primary keys to new rows, but because the new leader's counter lagged behind the old leader's, it

reused some primary keys that were previously assigned by the old leader. These primary keys were also used in a Redis store, so the reuse of primary keys resulted in inconsistency between MySQL and Redis, which caused some private data to be disclosed to the wrong users.

- In certain fault scenarios (see [Chapter 8](#)), it could happen that two nodes both believe that they are the leader. This situation is called *split brain*, and it is dangerous: if both leaders accept writes, and there is no process for resolving conflicts (see [“Multi-Leader Replication” on page 60](#)), data is likely to be lost or corrupted. As a safety catch, some systems have a mechanism to shut down one node if two leaders are detected.<sup>ii</sup> However, if this mechanism is not carefully designed, you can end up with both nodes being shut down [14].
- What is the right timeout before the leader is declared dead? A longer timeout means a longer time to recovery in the case where the leader fails. However, if the timeout is too short, there could be unnecessary failovers. For example, a temporary load spike could cause a node’s response time to increase above the timeout, or a network glitch could cause delayed packets. If the system is already struggling with high load or network problems, an unnecessary failover is likely to make the situation worse, not better.

There are no easy solutions to these problems. For this reason, some operations teams prefer to perform failovers manually, even if the software supports automatic failover.

These issues—node failures; unreliable networks; and trade-offs around replica consistency, durability, availability, and latency—are in fact fundamental problems in distributed systems. In [Chapter 8](#) and [Chapter 9](#) we will discuss them in greater depth.

## Implementation of Replication Logs

How does leader-based replication work under the hood? Several different replication methods are used in practice, so let’s look at each one briefly.

### Statement-based replication

In the simplest case, the leader logs every write request (*statement*) that it executes and sends that statement log to its followers. For a relational database, this means that every INSERT, UPDATE, or DELETE statement is forwarded to followers, and each follower parses and executes that SQL statement as if it had been received from a client.

---

ii. This approach is known as *fencing* or, more emphatically, *Shoot The Other Node In The Head* (STONITH). We will discuss fencing in more detail in [“The leader and the lock” on page 119](#).

Although this may sound reasonable, there are various ways in which this approach to replication can break down:

- Any statement that calls a nondeterministic function, such as `NOW()` to get the current date and time or `RAND()` to get a random number, is likely to generate a different value on each replica.
- If statements use an autoincrementing column, or if they depend on the existing data in the database (e.g., `UPDATE ... WHERE <some condition>`), they must be executed in exactly the same order on each replica, or else they may have a different effect. This can be limiting when there are multiple concurrently executing transactions.
- Statements that have side effects (e.g., triggers, stored procedures, user-defined functions) may result in different side effects occurring on each replica, unless the side effects are absolutely deterministic.

It is possible to work around those issues—for example, the leader can replace any nondeterministic function calls with a fixed return value when the statement is logged so that the followers all get the same value. However, because there are so many edge cases, other replication methods are now generally preferred.

Statement-based replication was used in MySQL before version 5.1. It is still sometimes used today, as it is quite compact, but by default MySQL now switches to row-based replication (discussed shortly) if there is any nondeterminism in a statement. VoltDB uses statement-based replication, and makes it safe by requiring transactions to be deterministic [15].

### Write-ahead log (WAL) shipping

In [Chapter 3](#) we discussed how storage engines represent data on disk, and we found that usually every write is appended to a log:

- In the case of a log-structured storage engine (see [“SSTables and LSM-Trees” on page 8](#)), this log is the main place for storage. Log segments are compacted and garbage-collected in the background.
- In the case of a B-tree (see [“B-Trees” on page 11](#)), which overwrites individual disk blocks, every modification is first written to a write-ahead log so that the index can be restored to a consistent state after a crash.

In either case, the log is an append-only sequence of bytes containing all writes to the database. We can use the exact same log to build a replica on another node: besides writing the log to disk, the leader also sends it across the network to its followers. When the follower processes this log, it builds a copy of the exact same data structures as found on the leader.

This method of replication is used in PostgreSQL and Oracle, among others [16]. The main disadvantage is that the log describes the data on a very low level: a WAL contains details of which bytes were changed in which disk blocks. This makes replication closely coupled to the storage engine. If the database changes its storage format from one version to another, it is typically not possible to run different versions of the database software on the leader and the followers.

That may seem like a minor implementation detail, but it can have a big operational impact. If the replication protocol allows the follower to use a newer software version than the leader, you can perform a zero-downtime upgrade of the database software by first upgrading the followers and then performing a failover to make one of the upgraded nodes the new leader. If the replication protocol does not allow this version mismatch, as is often the case with WAL shipping, such upgrades require downtime.

### Logical (row-based) log replication

An alternative is to use different log formats for replication and for the storage engine, which allows the replication log to be decoupled from the storage engine internals. This kind of replication log is called a *logical log*, to distinguish it from the storage engine's (*physical*) data representation.

A logical log for a relational database is usually a sequence of records describing writes to database tables at the granularity of a row:

- For an inserted row, the log contains the new values of all columns.
- For a deleted row, the log contains enough information to uniquely identify the row that was deleted. Typically this would be the primary key, but if there is no primary key on the table, the old values of all columns need to be logged.
- For an updated row, the log contains enough information to uniquely identify the updated row, and the new values of all columns (or at least the new values of all columns that changed).

A transaction that modifies several rows generates several such log records, followed by a record indicating that the transaction was committed. MySQL's binlog (when configured to use row-based replication) uses this approach [17].

Since a logical log is decoupled from the storage engine internals, it can more easily be kept backward compatible, allowing the leader and the follower to run different versions of the database software, or even different storage engines.

A logical log format is also easier for external applications to parse. This aspect is useful if you want to send the contents of a database to an external system, such as a data warehouse for offline analysis, or for building custom indexes and caches [18]. This technique is called *change data capture*, and we will return to it in Chapter 11.

## Trigger-based replication

The replication approaches described so far are implemented by the database system, without involving any application code. In many cases, that's what you want—but there are some circumstances where more flexibility is needed. For example, if you want to only replicate a subset of the data, or want to replicate from one kind of database to another, or if you need conflict resolution logic (see “[Handling Write Conflicts](#)” on page 63), then you may need to move replication up to the application layer.

Some tools, such as Oracle GoldenGate [19], can make data changes available to an application by reading the database log. An alternative is to use features that are available in many relational databases: *triggers* and *stored procedures*.

A trigger lets you register custom application code that is automatically executed when a data change (write transaction) occurs in a database system. The trigger has the opportunity to log this change into a separate table, from which it can be read by an external process. That external process can then apply any necessary application logic and replicate the data change to another system. Databus for Oracle [20] and Bucardo for Postgres [21] work like this, for example.

Trigger-based replication typically has greater overheads than other replication methods, and is more prone to bugs and limitations than the database's built-in replication. However, it can nevertheless be useful due to its flexibility.

## Problems with Replication Lag

Being able to tolerate node failures is just one reason for wanting replication. As mentioned in the introduction to Part II, other reasons are scalability (processing more requests than a single machine can handle) and latency (placing replicas geographically closer to users).

Leader-based replication requires all writes to go through a single node, but read-only queries can go to any replica. For workloads that consist of mostly reads and only a small percentage of writes (a common pattern on the web), there is an attractive option: create many followers, and distribute the read requests across those followers. This removes load from the leader and allows read requests to be served by nearby replicas.

In this *read-scaling* architecture, you can increase the capacity for serving read-only requests simply by adding more followers. However, this approach only realistically works with asynchronous replication—if you tried to synchronously replicate to all followers, a single node failure or network outage would make the entire system unavailable for writing. And the more nodes you have, the likelier it is that one will be down, so a fully synchronous configuration would be very unreliable.

Unfortunately, if an application reads from an *asynchronous* follower, it may see outdated information if the follower has fallen behind. This leads to apparent inconsistencies in the database: if you run the same query on the leader and a follower at the same time, you may get different results, because not all writes have been reflected in the follower. This inconsistency is just a temporary state—if you stop writing to the database and wait a while, the followers will eventually catch up and become consistent with the leader. For that reason, this effect is known as *eventual consistency* [22, 23].<sup>iii</sup>

The term “eventually” is deliberately vague: in general, there is no limit to how far a replica can fall behind. In normal operation, the delay between a write happening on the leader and being reflected on a follower—the *replication lag*—may be only a fraction of a second, and not noticeable in practice. However, if the system is operating near capacity or if there is a problem in the network, the lag can easily increase to several seconds or even minutes.

When the lag is so large, the inconsistencies it introduces are not just a theoretical issue but a real problem for applications. In this section we will highlight three examples of problems that are likely to occur when there is replication lag and outline some approaches to solving them.

## Reading Your Own Writes

Many applications let the user submit some data and then view what they have submitted. This might be a record in a customer database, or a comment on a discussion thread, or something else of that sort. When new data is submitted, it must be sent to the leader, but when the user views the data, it can be read from a follower. This is especially appropriate if data is frequently viewed but only occasionally written.

With asynchronous replication, there is a problem, illustrated in [Figure 5-3](#): if the user views the data shortly after making a write, the new data may not yet have reached the replica. To the user, it looks as though the data they submitted was lost, so they will be understandably unhappy.

---

iii. The term *eventual consistency* was coined by Douglas Terry et al. [24], popularized by Werner Vogels [22], and became the battle cry of many NoSQL projects. However, not only NoSQL databases are eventually consistent: followers in an asynchronously replicated relational database have the same characteristics.

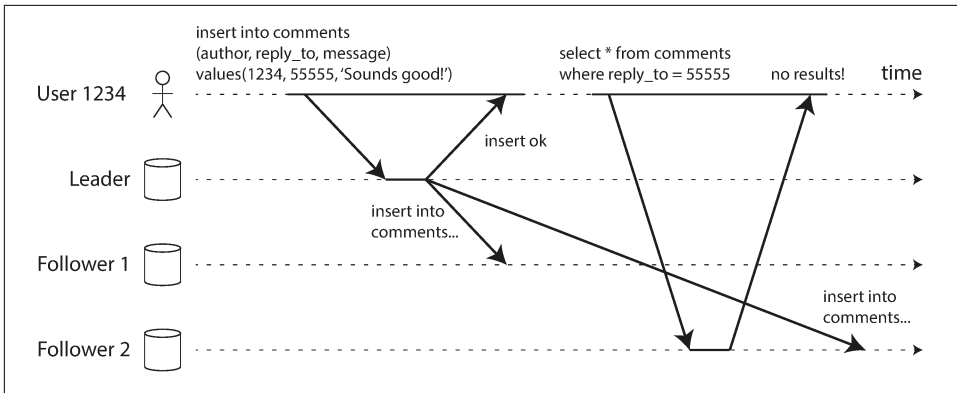

Figure 5-3. A user makes a write, followed by a read from a stale replica. To prevent this anomaly, we need read-after-write consistency.

In this situation, we need *read-after-write consistency*, also known as *read-your-writes consistency* [24]. This is a guarantee that if the user reloads the page, they will always see any updates they submitted themselves. It makes no promises about other users: other users' updates may not be visible until some later time. However, it reassures the user that their own input has been saved correctly.

How can we implement read-after-write consistency in a system with leader-based replication? There are various possible techniques. To mention a few:

- When reading something that the user may have modified, read it from the leader; otherwise, read it from a follower. This requires that you have some way of knowing whether something might have been modified, without actually querying it. For example, user profile information on a social network is normally only editable by the owner of the profile, not by anybody else. Thus, a simple rule is: always read the user's own profile from the leader, and any other users' profiles from a follower.
- If most things in the application are potentially editable by the user, that approach won't be effective, as most things would have to be read from the leader (negating the benefit of read scaling). In that case, other criteria may be used to decide whether to read from the leader. For example, you could track the time of the last update and, for one minute after the last update, make all reads from the leader. You could also monitor the replication lag on followers and prevent queries on any follower that is more than one minute behind the leader.
- The client can remember the timestamp of its most recent write—then the system can ensure that the replica serving any reads for that user reflects updates at least until that timestamp. If a replica is not sufficiently up to date, either the read can be handled by another replica or the query can wait until the replica has

caught up. The timestamp could be a *logical timestamp* (something that indicates ordering of writes, such as the log sequence number) or the actual system clock (in which case clock synchronization becomes critical; see “Unreliable Clocks” on page 105).

- If your replicas are distributed across multiple datacenters (for geographical proximity to users or for availability), there is additional complexity. Any request that needs to be served by the leader must be routed to the datacenter that contains the leader.

Another complication arises when the same user is accessing your service from multiple devices, for example a desktop web browser and a mobile app. In this case you may want to provide *cross-device* read-after-write consistency: if the user enters some information on one device and then views it on another device, they should see the information they just entered.

In this case, there are some additional issues to consider:

- Approaches that require remembering the timestamp of the user’s last update become more difficult, because the code running on one device doesn’t know what updates have happened on the other device. This metadata will need to be centralized.
- If your replicas are distributed across different datacenters, there is no guarantee that connections from different devices will be routed to the same datacenter. (For example, if the user’s desktop computer uses the home broadband connection and their mobile device uses the cellular data network, the devices’ network routes may be completely different.) If your approach requires reading from the leader, you may first need to route requests from all of a user’s devices to the same datacenter.

## Monotonic Reads

Our second example of an anomaly that can occur when reading from asynchronous followers is that it’s possible for a user to see things *moving backward in time*.

This can happen if a user makes several reads from different replicas. For example, [Figure 5-4](#) shows user 2345 making the same query twice, first to a follower with little lag, then to a follower with greater lag. (This scenario is quite likely if the user refreshes a web page, and each request is routed to a random server.) The first query returns a comment that was recently added by user 1234, but the second query doesn’t return anything because the lagging follower has not yet picked up that write. In effect, the second query observes the system state at an earlier point in time than the first query. This wouldn’t be so bad if the first query hadn’t returned anything, because user 2345 probably wouldn’t know that user 1234 had recently added a com-



ment. However, it's very confusing for user 2345 if they first see user 1234's comment appear, and then see it disappear again.

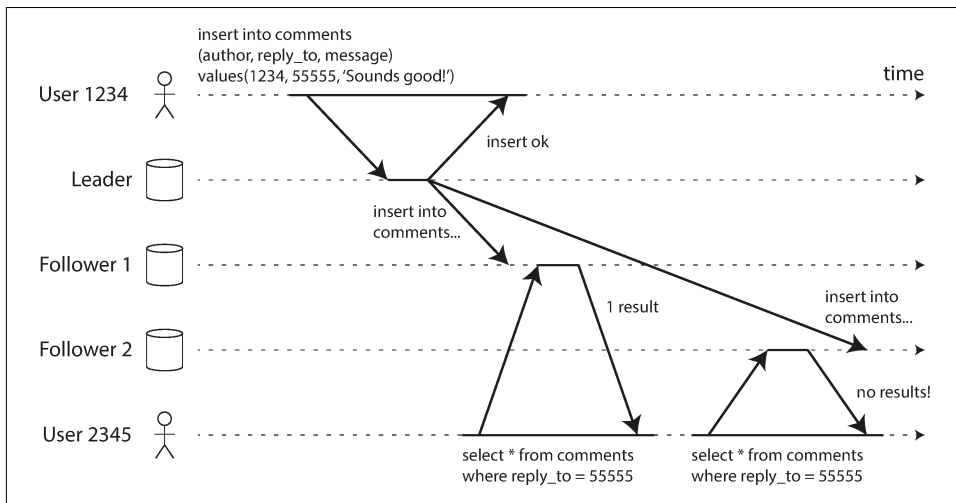

Figure 5-4. A user first reads from a fresh replica, then from a stale replica. Time appears to go backward. To prevent this anomaly, we need monotonic reads.

*Monotonic reads* [23] is a guarantee that this kind of anomaly does not happen. It's a lesser guarantee than strong consistency, but a stronger guarantee than eventual consistency. When you read data, you may see an old value; monotonic reads only means that if one user makes several reads in sequence, they will not see time go backward—i.e., they will not read older data after having previously read newer data.

One way of achieving monotonic reads is to make sure that each user always makes their reads from the same replica (different users can read from different replicas). For example, the replica can be chosen based on a hash of the user ID, rather than randomly. However, if that replica fails, the user's queries will need to be rerouted to another replica.

## Consistent Prefix Reads

Our third example of replication lag anomalies concerns violation of causality. Imagine the following short dialog between Mr. Poons and Mrs. Cake:

*Mr. Poons*

How far into the future can you see, Mrs. Cake?

*Mrs. Cake*

About ten seconds usually, Mr. Poons.

There is a causal dependency between those two sentences: Mrs. Cake heard Mr. Poons’s question and answered it.

Now, imagine a third person is listening to this conversation through followers. The things said by Mrs. Cake go through a follower with little lag, but the things said by Mr. Poons have a longer replication lag (see [Figure 5-5](#)). This observer would hear the following:

*Mrs. Cake*

About ten seconds usually, Mr. Poons.

*Mr. Poons*

How far into the future can you see, Mrs. Cake?

To the observer it looks as though Mrs. Cake is answering the question before Mr. Poons has even asked it. Such psychic powers are impressive, but very confusing [25].

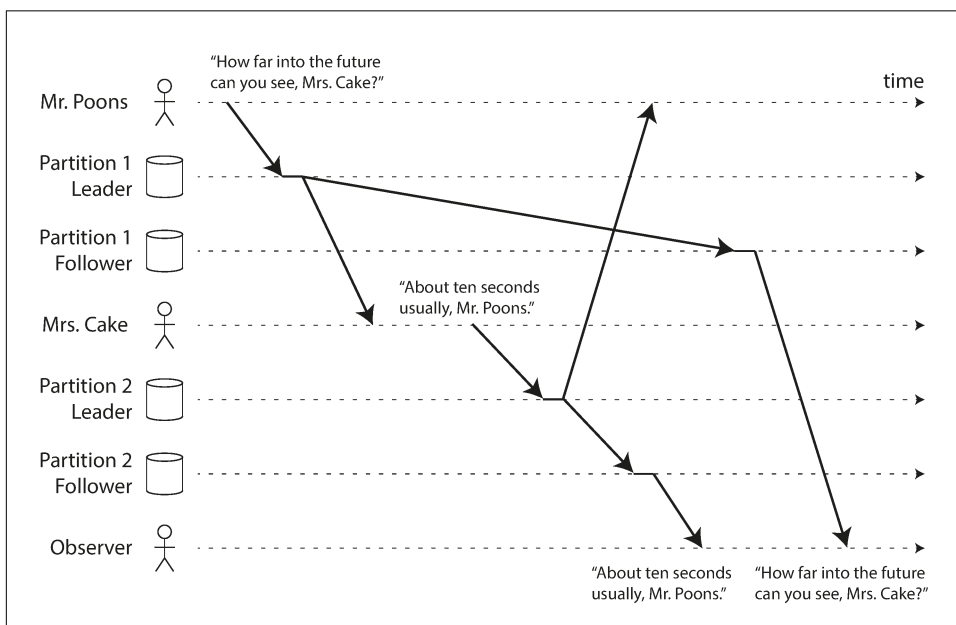

*Figure 5-5. If some partitions are replicated slower than others, an observer may see the answer before they see the question.*

Preventing this kind of anomaly requires another type of guarantee: *consistent prefix reads* [23]. This guarantee says that if a sequence of writes happens in a certain order, then anyone reading those writes will see them appear in the same order.

This is a particular problem in partitioned (sharded) databases, which we will discuss in Chapter 6. If the database always applies writes in the same order, reads always see a consistent prefix, so this anomaly cannot happen. However, in many distributed

databases, different partitions operate independently, so there is no global ordering of writes: when a user reads from the database, they may see some parts of the database in an older state and some in a newer state.

One solution is to make sure that any writes that are causally related to each other are written to the same partition—but in some applications that cannot be done efficiently. There are also algorithms that explicitly keep track of causal dependencies, a topic that we will return to in “The “happens-before” relationship and concurrency” on page 78.

## Solutions for Replication Lag

When working with an eventually consistent system, it is worth thinking about how the application behaves if the replication lag increases to several minutes or even hours. If the answer is “no problem,” that’s great. However, if the result is a bad experience for users, it’s important to design the system to provide a stronger guarantee, such as read-after-write. Pretending that replication is synchronous when in fact it is asynchronous is a recipe for problems down the line.

As discussed earlier, there are ways in which an application can provide a stronger guarantee than the underlying database—for example, by performing certain kinds of reads on the leader. However, dealing with these issues in application code is complex and easy to get wrong.

It would be better if application developers didn’t have to worry about subtle replication issues and could just trust their databases to “do the right thing.” This is why *transactions* exist: they are a way for a database to provide stronger guarantees so that the application can be simpler.

Single-node transactions have existed for a long time. However, in the move to distributed (replicated and partitioned) databases, many systems have abandoned them, claiming that transactions are too expensive in terms of performance and availability, and asserting that eventual consistency is inevitable in a scalable system. There is some truth in that statement, but it is overly simplistic, and we will develop a more nuanced view over the course of the rest of this book. We will return to the topic of transactions in Chapters 7 and 9, and we will discuss some alternative mechanisms in Part III.

# Multi-Leader Replication

So far in this chapter we have only considered replication architectures using a single leader. Although that is a common approach, there are interesting alternatives.

Leader-based replication has one major downside: there is only one leader, and all writes must go through it.<sup>iv</sup> If you can't connect to the leader for any reason, for example due to a network interruption between you and the leader, you can't write to the database.

A natural extension of the leader-based replication model is to allow more than one node to accept writes. Replication still happens in the same way: each node that processes a write must forward that data change to all the other nodes. We call this a *multi-leader* configuration (also known as *master-master* or *active/active replication*). In this setup, each leader simultaneously acts as a follower to the other leaders.

## Use Cases for Multi-Leader Replication

It rarely makes sense to use a multi-leader setup within a single datacenter, because the benefits rarely outweigh the added complexity. However, there are some situations in which this configuration is reasonable.

### Multi-datacenter operation

Imagine you have a database with replicas in several different datacenters (perhaps so that you can tolerate failure of an entire datacenter, or perhaps in order to be closer to your users). With a normal leader-based replication setup, the leader has to be in *one* of the datacenters, and all writes must go through that datacenter.

In a multi-leader configuration, you can have a leader in *each* datacenter. [Figure 5-6](#) shows what this architecture might look like. Within each datacenter, regular leader-follower replication is used; between datacenters, each datacenter's leader replicates its changes to the leaders in other datacenters.

---

iv. If the database is partitioned (see Chapter 6), each partition has one leader. Different partitions may have their leaders on different nodes, but each partition must nevertheless have one leader node.

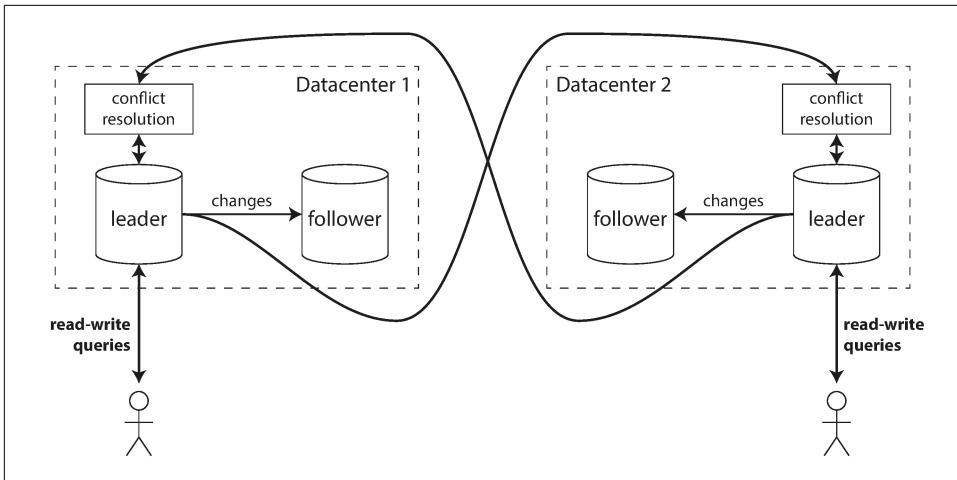

Figure 5-6. Multi-leader replication across multiple datacenters.

Let's compare how the single-leader and multi-leader configurations fare in a multi-datacenter deployment:

#### *Performance*

In a single-leader configuration, every write must go over the internet to the datacenter with the leader. This can add significant latency to writes and might contravene the purpose of having multiple datacenters in the first place. In a multi-leader configuration, every write can be processed in the local datacenter and is replicated asynchronously to the other datacenters. Thus, the inter-datacenter network delay is hidden from users, which means the perceived performance may be better.

#### *Tolerance of datacenter outages*

In a single-leader configuration, if the datacenter with the leader fails, failover can promote a follower in another datacenter to be leader. In a multi-leader configuration, each datacenter can continue operating independently of the others, and replication catches up when the failed datacenter comes back online.

#### *Tolerance of network problems*

Traffic between datacenters usually goes over the public internet, which may be less reliable than the local network within a datacenter. A single-leader configuration is very sensitive to problems in this inter-datacenter link, because writes are made synchronously over this link. A multi-leader configuration with asynchronous replication can usually tolerate network problems better: a temporary network interruption does not prevent writes being processed.

Some databases support multi-leader configurations by default, but it is also often implemented with external tools, such as Tungsten Replicator for MySQL [26], BDR for PostgreSQL [27], and GoldenGate for Oracle [19].

Although multi-leader replication has advantages, it also has a big downside: the same data may be concurrently modified in two different datacenters, and those write conflicts must be resolved (indicated as “conflict resolution” in [Figure 5-6](#)). We will discuss this issue in [“Handling Write Conflicts” on page 63](#).

As multi-leader replication is a somewhat retrofitted feature in many databases, there are often subtle configuration pitfalls and surprising interactions with other database features. For example, autoincrementing keys, triggers, and integrity constraints can be problematic. For this reason, multi-leader replication is often considered dangerous territory that should be avoided if possible [28].

### **Clients with offline operation**

Another situation in which multi-leader replication is appropriate is if you have an application that needs to continue to work while it is disconnected from the internet.

For example, consider the calendar apps on your mobile phone, your laptop, and other devices. You need to be able to see your meetings (make read requests) and enter new meetings (make write requests) at any time, regardless of whether your device currently has an internet connection. If you make any changes while you are offline, they need to be synced with a server and your other devices when the device is next online.

In this case, every device has a local database that acts as a leader (it accepts write requests), and there is an asynchronous multi-leader replication process (sync) between the replicas of your calendar on all of your devices. The replication lag may be hours or even days, depending on when you have internet access available.

From an architectural point of view, this setup is essentially the same as multi-leader replication between datacenters, taken to the extreme: each device is a “datacenter,” and the network connection between them is extremely unreliable. As the rich history of broken calendar sync implementations demonstrates, multi-leader replication is a tricky thing to get right.

There are tools that aim to make this kind of multi-leader configuration easier. For example, CouchDB is designed for this mode of operation [29].

### **Collaborative editing**

*Real-time collaborative editing* applications allow several people to edit a document simultaneously. For example, Etherpad [30] and Google Docs [31] allow multiple people to concurrently edit a text document or spreadsheet (the algorithm is briefly discussed in [“Automatic Conflict Resolution” on page 66](#)).

We don't usually think of collaborative editing as a database replication problem, but it has a lot in common with the previously mentioned offline editing use case. When one user edits a document, the changes are instantly applied to their local replica (the state of the document in their web browser or client application) and asynchronously replicated to the server and any other users who are editing the same document.

If you want to guarantee that there will be no editing conflicts, the application must obtain a lock on the document before a user can edit it. If another user wants to edit the same document, they first have to wait until the first user has committed their changes and released the lock. This collaboration model is equivalent to single-leader replication with transactions on the leader.

However, for faster collaboration, you may want to make the unit of change very small (e.g., a single keystroke) and avoid locking. This approach allows multiple users to edit simultaneously, but it also brings all the challenges of multi-leader replication, including requiring conflict resolution [32].

## Handling Write Conflicts

The biggest problem with multi-leader replication is that write conflicts can occur, which means that conflict resolution is required.

For example, consider a wiki page that is simultaneously being edited by two users, as shown in [Figure 5-7](#). User 1 changes the title of the page from A to B, and user 2 changes the title from A to C at the same time. Each user's change is successfully applied to their local leader. However, when the changes are asynchronously replicated, a conflict is detected [33]. This problem does not occur in a single-leader database.

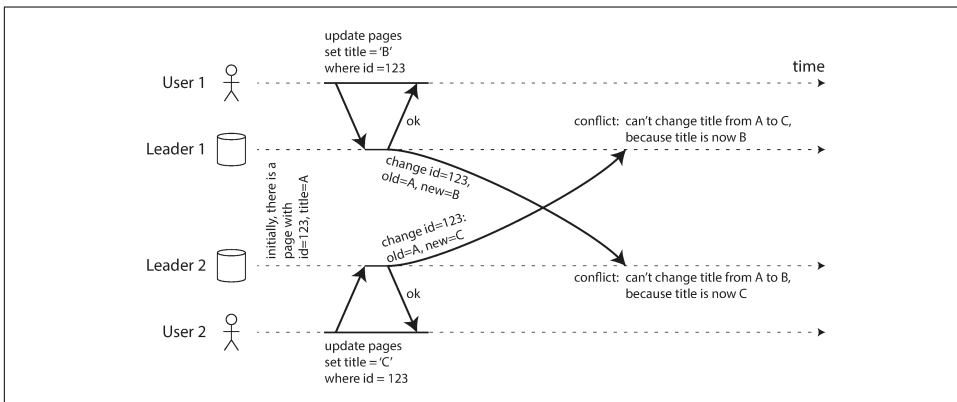

Figure 5-7. A write conflict caused by two leaders concurrently updating the same record.

## Synchronous versus asynchronous conflict detection

In a single-leader database, the second writer will either block and wait for the first write to complete, or abort the second write transaction, forcing the user to retry the write. On the other hand, in a multi-leader setup, both writes are successful, and the conflict is only detected asynchronously at some later point in time. At that time, it may be too late to ask the user to resolve the conflict.

In principle, you could make the conflict detection synchronous—i.e., wait for the write to be replicated to all replicas before telling the user that the write was successful. However, by doing so, you would lose the main advantage of multi-leader replication: allowing each replica to accept writes independently. If you want synchronous conflict detection, you might as well just use single-leader replication.

## Conflict avoidance

The simplest strategy for dealing with conflicts is to avoid them: if the application can ensure that all writes for a particular record go through the same leader, then conflicts cannot occur. Since many implementations of multi-leader replication handle conflicts quite poorly, avoiding conflicts is a frequently recommended approach [34].

For example, in an application where a user can edit their own data, you can ensure that requests from a particular user are always routed to the same datacenter and use the leader in that datacenter for reading and writing. Different users may have different “home” datacenters (perhaps picked based on geographic proximity to the user), but from any one user’s point of view the configuration is essentially single-leader.

However, sometimes you might want to change the designated leader for a record—perhaps because one datacenter has failed and you need to reroute traffic to another datacenter, or perhaps because a user has moved to a different location and is now closer to a different datacenter. In this situation, conflict avoidance breaks down, and you have to deal with the possibility of concurrent writes on different leaders.

## Converging toward a consistent state

A single-leader database applies writes in a sequential order: if there are several updates to the same field, the last write determines the final value of the field.

In a multi-leader configuration, there is no defined ordering of writes, so it’s not clear what the final value should be. In [Figure 5-7](#), at leader 1 the title is first updated to B and then to C; at leader 2 it is first updated to C and then to B. Neither order is “more correct” than the other.

If each replica simply applied writes in the order that it saw the writes, the database would end up in an inconsistent state: the final value would be C at leader 1 and B at leader 2. That is not acceptable—every replication system must ensure that the data is eventually the same in all replicas. Thus, the database must resolve the conflict in a



*convergent* way, which means that all replicas must arrive at the same final value when all changes have been replicated.

There are various ways of achieving convergent conflict resolution:

- Give each write a unique ID (e.g., a timestamp, a long random number, a UUID, or a hash of the key and value), pick the write with the highest ID as the *winner*, and throw away the other writes. If a timestamp is used, this technique is known as *last write wins* (LWW). Although this approach is popular, it is dangerously prone to data loss [35]. We will discuss LWW in more detail at the end of this chapter (“**Detecting Concurrent Writes**” on page 76).
- Give each replica a unique ID, and let writes that originated at a higher-numbered replica always take precedence over writes that originated at a lower-numbered replica. This approach also implies data loss.
- Somehow merge the values together—e.g., order them alphabetically and then concatenate them (in [Figure 5-7](#), the merged title might be something like “B/C”).
- Record the conflict in an explicit data structure that preserves all information, and write application code that resolves the conflict at some later time (perhaps by prompting the user).

### Custom conflict resolution logic

As the most appropriate way of resolving a conflict may depend on the application, most multi-leader replication tools let you write conflict resolution logic using application code. That code may be executed on write or on read:

#### *On write*

As soon as the database system detects a conflict in the log of replicated changes, it calls the conflict handler. For example, Bucardo allows you to write a snippet of Perl for this purpose. This handler typically cannot prompt a user—it runs in a background process and it must execute quickly.

#### *On read*

When a conflict is detected, all the conflicting writes are stored. The next time the data is read, these multiple versions of the data are returned to the application. The application may prompt the user or automatically resolve the conflict, and write the result back to the database. CouchDB works this way, for example.

Note that conflict resolution usually applies at the level of an individual row or document, not for an entire transaction [36]. Thus, if you have a transaction that atomically makes several different writes (see Chapter 7), each write is still considered separately for the purposes of conflict resolution.

## Automatic Conflict Resolution

Conflict resolution rules can quickly become complicated, and custom code can be error-prone. Amazon is a frequently cited example of surprising effects due to a conflict resolution handler: for some time, the conflict resolution logic on the shopping cart would preserve items added to the cart, but not items removed from the cart. Thus, customers would sometimes see items reappearing in their carts even though they had previously been removed [37].

There has been some interesting research into automatically resolving conflicts caused by concurrent data modifications. A few lines of research are worth mentioning:

- *Conflict-free replicated datatypes* (CRDTs) [32, 38] are a family of data structures for sets, maps (dictionaries), ordered lists, counters, etc. that can be concurrently edited by multiple users, and which automatically resolve conflicts in sensible ways. Some CRDTs have been implemented in Riak 2.0 [39, 40].
- *Mergeable persistent data structures* [41] track history explicitly, similarly to the Git version control system, and use a three-way merge function (whereas CRDTs use two-way merges).
- *Operational transformation* [42] is the conflict resolution algorithm behind collaborative editing applications such as Etherpad [30] and Google Docs [31]. It was designed particularly for concurrent editing of an ordered list of items, such as the list of characters that constitute a text document.

Implementations of these algorithms in databases are still young, but it's likely that they will be integrated into more replicated data systems in the future. Automatic conflict resolution could make multi-leader data synchronization much simpler for applications to deal with.

### What is a conflict?

Some kinds of conflict are obvious. In the example in [Figure 5-7](#), two writes concurrently modified the same field in the same record, setting it to two different values. There is little doubt that this is a conflict.

Other kinds of conflict can be more subtle to detect. For example, consider a meeting room booking system: it tracks which room is booked by which group of people at which time. This application needs to ensure that each room is only booked by one group of people at any one time (i.e., there must not be any overlapping bookings for the same room). In this case, a conflict may arise if two different bookings are created for the same room at the same time. Even if the application checks availability before

allowing a user to make a booking, there can be a conflict if the two bookings are made on two different leaders.

There isn't a quick ready-made answer, but in the following chapters we will trace a path toward a good understanding of this problem. We will see some more examples of conflicts in Chapter 7, and in Chapter 12 we will discuss scalable approaches for detecting and resolving conflicts in a replicated system.

## Multi-Leader Replication Topologies

A *replication topology* describes the communication paths along which writes are propagated from one node to another. If you have two leaders, like in Figure 5-7, there is only one plausible topology: leader 1 must send all of its writes to leader 2, and vice versa. With more than two leaders, various different topologies are possible. Some examples are illustrated in Figure 5-8.

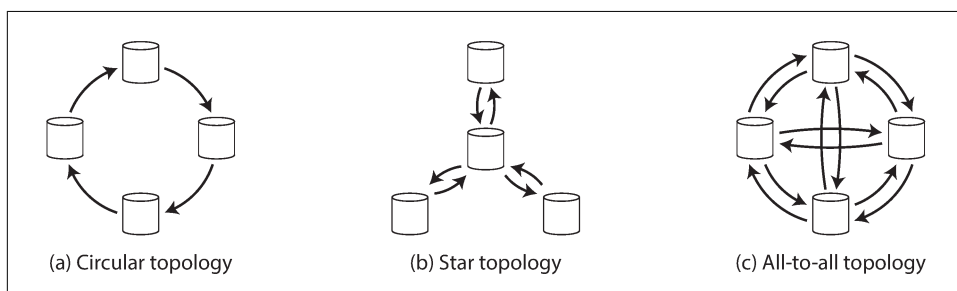

Figure 5-8. Three example topologies in which multi-leader replication can be set up.

The most general topology is *all-to-all* (Figure 5-8 [c]), in which every leader sends its writes to every other leader. However, more restricted topologies are also used: for example, MySQL by default supports only a *circular topology* [34], in which each node receives writes from one node and forwards those writes (plus any writes of its own) to one other node. Another popular topology has the shape of a *star*:<sup>v</sup> one designated root node forwards writes to all of the other nodes. The star topology can be generalized to a tree.

In circular and star topologies, a write may need to pass through several nodes before it reaches all replicas. Therefore, nodes need to forward data changes they receive from other nodes. To prevent infinite replication loops, each node is given a unique identifier, and in the replication log, each write is tagged with the identifiers of all the nodes it has passed through [43]. When a node receives a data change that is tagged

v. Not to be confused with a *star schema* (see “Stars and Snowflakes: Schemas for Analytics” on page 25), which describes the structure of a data model, not the communication topology between nodes.

with its own identifier, that data change is ignored, because the node knows that it has already been processed.

A problem with circular and star topologies is that if just one node fails, it can interrupt the flow of replication messages between other nodes, causing them to be unable to communicate until the node is fixed. The topology could be reconfigured to work around the failed node, but in most deployments such reconfiguration would have to be done manually. The fault tolerance of a more densely connected topology (such as all-to-all) is better because it allows messages to travel along different paths, avoiding a single point of failure.

On the other hand, all-to-all topologies can have issues too. In particular, some network links may be faster than others (e.g., due to network congestion), with the result that some replication messages may “overtake” others, as illustrated in [Figure 5-9](#).

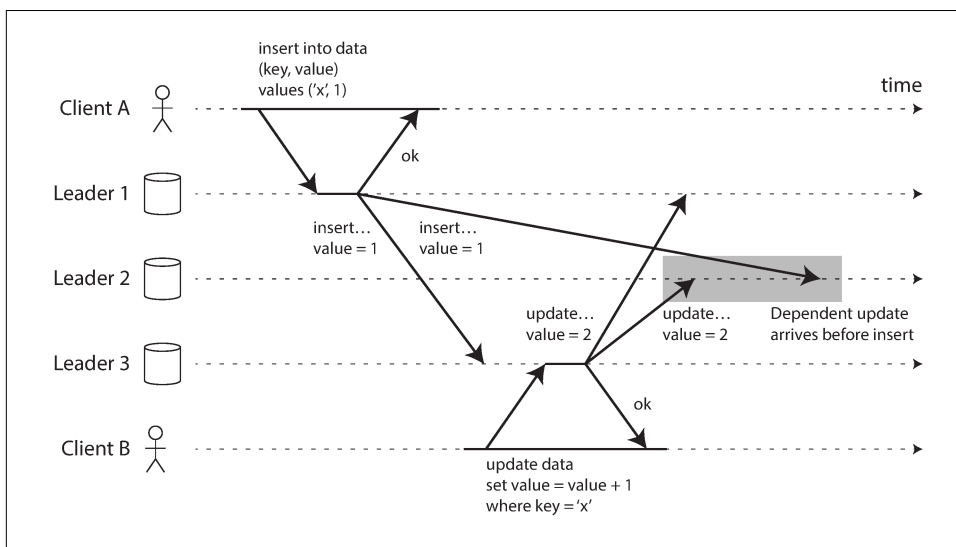

*Figure 5-9. With multi-leader replication, writes may arrive in the wrong order at some replicas.*

In [Figure 5-9](#), client A inserts a row into a table on leader 1, and client B updates that row on leader 3. However, leader 2 may receive the writes in a different order: it may first receive the update (which, from its point of view, is an update to a row that does not exist in the database) and only later receive the corresponding insert (which should have preceded the update).

This is a problem of causality, similar to the one we saw in “[Consistent Prefix Reads](#)” on [page 57](#): the update depends on the prior insert, so we need to make sure that all nodes process the insert first, and then the update. Simply attaching a timestamp to

every write is not sufficient, because clocks cannot be trusted to be sufficiently in sync to correctly order these events at leader 2 (see [Chapter 8](#)).

To order these events correctly, a technique called *version vectors* can be used, which we will discuss later in this chapter (see “[Detecting Concurrent Writes](#)” on page 76). However, conflict detection techniques are poorly implemented in many multi-leader replication systems. For example, at the time of writing, PostgreSQL BDR does not provide causal ordering of writes [27], and Tungsten Replicator for MySQL doesn’t even try to detect conflicts [34].

If you are using a system with multi-leader replication, it is worth being aware of these issues, carefully reading the documentation, and thoroughly testing your database to ensure that it really does provide the guarantees you believe it to have.

## Leaderless Replication

The replication approaches we have discussed so far in this chapter—single-leader and multi-leader replication—are based on the idea that a client sends a write request to one node (the leader), and the database system takes care of copying that write to the other replicas. A leader determines the order in which writes should be processed, and followers apply the leader’s writes in the same order.

Some data storage systems take a different approach, abandoning the concept of a leader and allowing any replica to directly accept writes from clients. Some of the earliest replicated data systems were leaderless [1, 44], but the idea was mostly forgotten during the era of dominance of relational databases. It once again became a fashionable architecture for databases after Amazon used it for its in-house *Dynamo* system [37].<sup>vi</sup> Riak, Cassandra, and Voldemort are open source datastores with leaderless replication models inspired by Dynamo, so this kind of database is also known as *Dynamo-style*.

In some leaderless implementations, the client directly sends its writes to several replicas, while in others, a coordinator node does this on behalf of the client. However, unlike a leader database, that coordinator does not enforce a particular ordering of writes. As we shall see, this difference in design has profound consequences for the way the database is used.

## Writing to the Database When a Node Is Down

Imagine you have a database with three replicas, and one of the replicas is currently unavailable—perhaps it is being rebooted to install a system update. In a leader-based

---

vi. Dynamo is not available to users outside of Amazon. Confusingly, AWS offers a hosted database product called *DynamoDB*, which uses a completely different architecture: it is based on single-leader replication.

configuration, if you want to continue processing writes, you may need to perform a failover (see “[Handling Node Outages](#)” on page 48).

On the other hand, in a leaderless configuration, failover does not exist. [Figure 5-10](#) shows what happens: the client (user 1234) sends the write to all three replicas in parallel, and the two available replicas accept the write but the unavailable replica misses it. Let’s say that it’s sufficient for two out of three replicas to acknowledge the write: after user 1234 has received two *ok* responses, we consider the write to be successful. The client simply ignores the fact that one of the replicas missed the write.

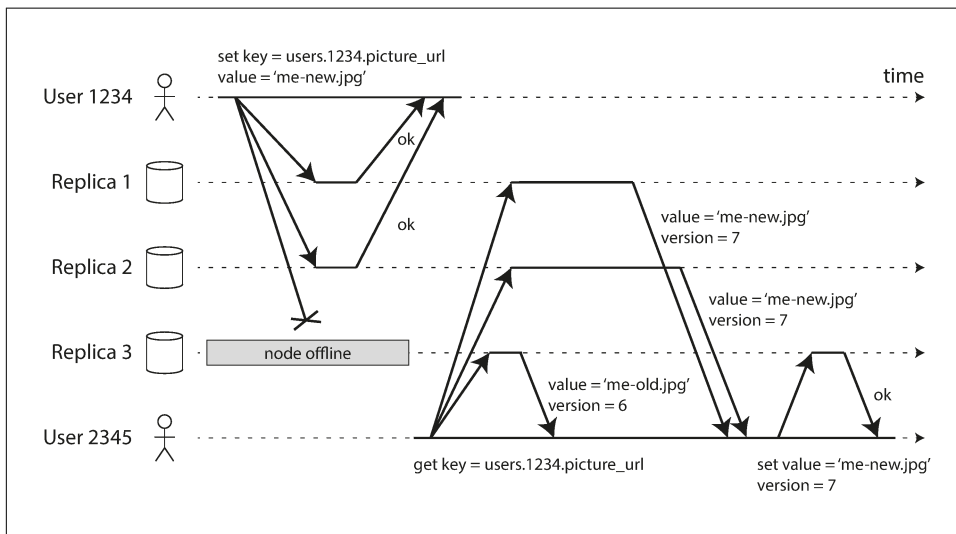

Figure 5-10. A quorum write, quorum read, and read repair after a node outage.

Now imagine that the unavailable node comes back online, and clients start reading from it. Any writes that happened while the node was down are missing from that node. Thus, if you read from that node, you may get *stale* (outdated) values as responses.

To solve that problem, when a client reads from the database, it doesn’t just send its request to one replica: *read requests are also sent to several nodes in parallel*. The client may get different responses from different nodes; i.e., the up-to-date value from one node and a stale value from another. Version numbers are used to determine which value is newer (see “[Detecting Concurrent Writes](#)” on page 76).

### Read repair and anti-entropy

The replication system should ensure that eventually all the data is copied to every replica. After an unavailable node comes back online, how does it catch up on the writes that it missed?

Two mechanisms are often used in Dynamo-style datastores:

### *Read repair*

When a client makes a read from several nodes in parallel, it can detect any stale responses. For example, in [Figure 5-10](#), user 2345 gets a version 6 value from replica 3 and a version 7 value from replicas 1 and 2. The client sees that replica 3 has a stale value and writes the newer value back to that replica. This approach works well for values that are frequently read.

### *Anti-entropy process*

In addition, some datastores have a background process that constantly looks for differences in the data between replicas and copies any missing data from one replica to another. Unlike the replication log in leader-based replication, this *anti-entropy process* does not copy writes in any particular order, and there may be a significant delay before data is copied.

Not all systems implement both of these; for example, Voldemort currently does not have an anti-entropy process. Note that without an anti-entropy process, values that are rarely read may be missing from some replicas and thus have reduced durability, because read repair is only performed when a value is read by the application.

## **Quorums for reading and writing**

In the example of [Figure 5-10](#), we considered the write to be successful even though it was only processed on two out of three replicas. What if only one out of three replicas accepted the write? How far can we push this?

If we know that every successful write is guaranteed to be present on at least two out of three replicas, that means at most one replica can be stale. Thus, if we read from at least two replicas, we can be sure that at least one of the two is up to date. If the third replica is down or slow to respond, reads can nevertheless continue returning an up-to-date value.

More generally, if there are  $n$  replicas, every write must be confirmed by  $w$  nodes to be considered successful, and we must query at least  $r$  nodes for each read. (In our example,  $n = 3$ ,  $w = 2$ ,  $r = 2$ .) As long as  $w + r > n$ , we expect to get an up-to-date value when reading, because at least one of the  $r$  nodes we're reading from must be up to date. Reads and writes that obey these  $r$  and  $w$  values are called *quorum* reads and writes [44].<sup>vii</sup> You can think of  $r$  and  $w$  as the minimum number of votes required for the read or write to be valid.

---

vii. Sometimes this kind of quorum is called a *strict quorum*, to contrast with *sloppy quorums* (discussed in [“Sloppy Quorums and Hinted Handoff”](#) on page 75).

In Dynamo-style databases, the parameters  $n$ ,  $w$ , and  $r$  are typically configurable. A common choice is to make  $n$  an odd number (typically 3 or 5) and to set  $w = r = (n + 1) / 2$  (rounded up). However, you can vary the numbers as you see fit. For example, a workload with few writes and many reads may benefit from setting  $w = n$  and  $r = 1$ . This makes reads faster, but has the disadvantage that just one failed node causes all database writes to fail.



There may be more than  $n$  nodes in the cluster, but any given value is stored only on  $n$  nodes. This allows the dataset to be partitioned, supporting datasets that are larger than you can fit on one node. We will return to partitioning in Chapter 6.

The quorum condition,  $w + r > n$ , allows the system to tolerate unavailable nodes as follows:

- If  $w < n$ , we can still process writes if a node is unavailable.
- If  $r < n$ , we can still process reads if a node is unavailable.
- With  $n = 3$ ,  $w = 2$ ,  $r = 2$  we can tolerate one unavailable node.
- With  $n = 5$ ,  $w = 3$ ,  $r = 3$  we can tolerate two unavailable nodes. This case is illustrated in [Figure 5-11](#).
- Normally, reads and writes are always sent to all  $n$  replicas in parallel. The parameters  $w$  and  $r$  determine how many nodes we wait for—i.e., how many of the  $n$  nodes need to report success before we consider the read or write to be successful.

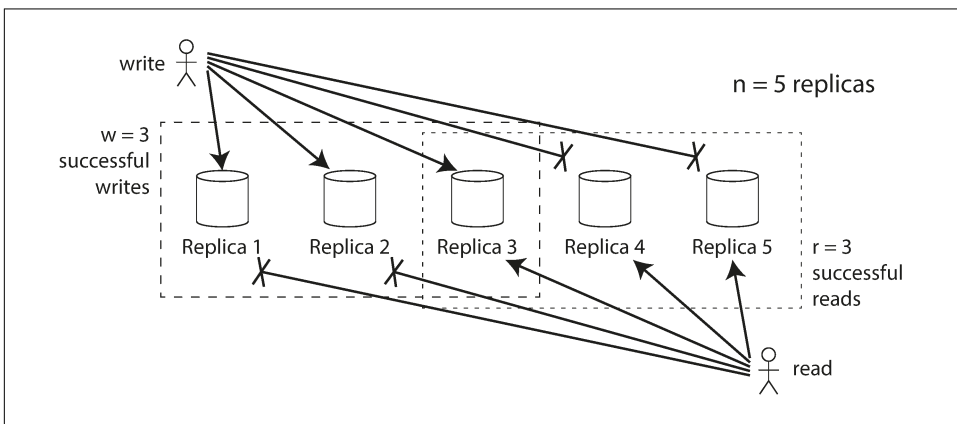

Figure 5-11. If  $w + r > n$ , at least one of the  $r$  replicas you read from must have seen the most recent successful write.



If fewer than the required  $w$  or  $r$  nodes are available, writes or reads return an error. A node could be unavailable for many reasons: because the node is down (crashed, powered down), due to an error executing the operation (can't write because the disk is full), due to a network interruption between the client and the node, or for any number of other reasons. We only care whether the node returned a successful response and don't need to distinguish between different kinds of fault.

## Limitations of Quorum Consistency

If you have  $n$  replicas, and you choose  $w$  and  $r$  such that  $w + r > n$ , you can generally expect every read to return the most recent value written for a key. This is the case because the set of nodes to which you've written and the set of nodes from which you've read must overlap. That is, among the nodes you read there must be at least one node with the latest value (illustrated in [Figure 5-11](#)).

Often,  $r$  and  $w$  are chosen to be a majority (more than  $n/2$ ) of nodes, because that ensures  $w + r > n$  while still tolerating up to  $n/2$  (rounded down) node failures. But quorums are not necessarily majorities—it only matters that the sets of nodes used by the read and write operations overlap in at least one node. Other quorum assignments are possible, which allows some flexibility in the design of distributed algorithms [45].

You may also set  $w$  and  $r$  to smaller numbers, so that  $w + r \leq n$  (i.e., the quorum condition is not satisfied). In this case, reads and writes will still be sent to  $n$  nodes, but a smaller number of successful responses is required for the operation to succeed.

With a smaller  $w$  and  $r$  you are more likely to read stale values, because it's more likely that your read didn't include the node with the latest value. On the upside, this configuration allows lower latency and higher availability: if there is a network interruption and many replicas become unreachable, there's a higher chance that you can continue processing reads and writes. Only after the number of reachable replicas falls below  $w$  or  $r$  does the database become unavailable for writing or reading, respectively.

However, even with  $w + r > n$ , there are likely to be edge cases where stale values are returned. These depend on the implementation, but possible scenarios include:

- If a sloppy quorum is used (see [“Sloppy Quorums and Hinted Handoff”](#) on page 75), the  $w$  writes may end up on different nodes than the  $r$  reads, so there is no longer a guaranteed overlap between the  $r$  nodes and the  $w$  nodes [46].
- If two writes occur concurrently, it is not clear which one happened first. In this case, the only safe solution is to merge the concurrent writes (see [“Handling Write Conflicts”](#) on page 63). If a winner is picked based on a timestamp (last write wins), writes can be lost due to clock skew [35]. We will return to this topic in [“Detecting Concurrent Writes”](#) on page 76.

- If a write happens concurrently with a read, the write may be reflected on only some of the replicas. In this case, it's undetermined whether the read returns the old or the new value.
- If a write succeeded on some replicas but failed on others (for example because the disks on some nodes are full), and overall succeeded on fewer than  $w$  replicas, it is not rolled back on the replicas where it succeeded. This means that if a write was reported as failed, subsequent reads may or may not return the value from that write [47].
- If a node carrying a new value fails, and its data is restored from a replica carrying an old value, the number of replicas storing the new value may fall below  $w$ , breaking the quorum condition.
- Even if everything is working correctly, there are edge cases in which you can get unlucky with the timing, as we shall see in Chapter 9.

Thus, although quorums appear to guarantee that a read returns the latest written value, in practice it is not so simple. Dynamo-style databases are generally optimized for use cases that can tolerate eventual consistency. The parameters  $w$  and  $r$  allow you to adjust the probability of stale values being read, but it's wise to not take them as absolute guarantees.

In particular, you usually do not get the guarantees discussed in “[Problems with Replication Lag](#)” on page 53 (reading your writes, monotonic reads, or consistent prefix reads), so the previously mentioned anomalies can occur in applications. Stronger guarantees generally require transactions or consensus. We will return to these topics in Chapter 7 and Chapter 9.

## Monitoring staleness

From an operational perspective, it's important to monitor whether your databases are returning up-to-date results. Even if your application can tolerate stale reads, you need to be aware of the health of your replication. If it falls behind significantly, it should alert you so that you can investigate the cause (for example, a problem in the network or an overloaded node).

For leader-based replication, the database typically exposes metrics for the replication lag, which you can feed into a monitoring system. This is possible because writes are applied to the leader and to followers in the same order, and each node has a position in the replication log (the number of writes it has applied locally). By subtracting a follower's current position from the leader's current position, you can measure the amount of replication lag.

However, in systems with leaderless replication, there is no fixed order in which writes are applied, which makes monitoring more difficult. Moreover, if the database only uses read repair (no anti-entropy), there is no limit to how old a value might be

—if a value is only infrequently read, the value returned by a stale replica may be ancient.

There has been some research on measuring replica staleness in databases with leaderless replication and predicting the expected percentage of stale reads depending on the parameters  $n$ ,  $w$ , and  $r$  [48]. This is unfortunately not yet common practice, but it would be good to include staleness measurements in the standard set of metrics for databases. Eventual consistency is a deliberately vague guarantee, but for operability it's important to be able to quantify “eventual.”

## Sloppy Quorums and Hinted Handoff

Databases with appropriately configured quorums can tolerate the failure of individual nodes without the need for failover. They can also tolerate individual nodes going slow (e.g. due to overload), because requests don't have to wait for all  $n$  nodes to respond—they can return when  $w$  or  $r$  nodes have responded. These characteristics make databases with leaderless replication appealing for use cases that require high availability and low latency, and that can tolerate occasional stale reads.

However, quorums (as described so far) are not as fault-tolerant as they could be. A network interruption can easily cut off a client from a large number of database nodes. Although those nodes are alive, and other clients may be able to connect to them, to a client that is cut off from the database nodes, they might as well be dead. In this situation, it's likely that fewer than  $w$  or  $r$  reachable nodes remain, so the client can no longer reach a quorum.

In a large cluster (with significantly more than  $n$  nodes) it's likely that the client can connect to *some* database nodes during the network interruption, just not to the nodes that it needs to assemble a quorum for a particular value. In that case, database designers face a trade-off:

- Is it better to return errors to all requests for which we cannot reach a quorum of  $w$  or  $r$  nodes?
- Or should we accept writes anyway, and write them to some nodes that are reachable but aren't among the  $n$  nodes on which the value usually lives?

The latter is known as a *sloppy quorum* [37]: writes and reads still require  $w$  and  $r$  successful responses, but those may include nodes that are not among the designated  $n$  “home” nodes for a value. By analogy, if you lock yourself out of your house, you may knock on the neighbor's door and ask whether you may stay on their couch temporarily.

Once the network interruption is fixed, any writes that one node temporarily accepted on behalf of another node are sent to the appropriate “home” nodes. This is

called *hinted handoff*. (Once you find the keys to your house again, your neighbor politely asks you to get off their couch and go home.)

Sloppy quorums are particularly useful for increasing write availability: as long as *any*  $w$  nodes are available, the database can accept writes. However, this means that even when  $w + r > n$ , you cannot be sure to read the latest value for a key, because the latest value may have been temporarily written to some nodes outside of  $n$  [47].

Thus, a sloppy quorum actually isn't a quorum at all in the traditional sense. It's only an assurance of durability, namely that the data is stored on  $w$  nodes somewhere. There is no guarantee that a read of  $r$  nodes will see it until the hinted handoff has completed.

Sloppy quorums are optional in all common Dynamo implementations. In Riak they are enabled by default, and in Cassandra and Voldemort they are disabled by default [46, 49, 50].

## Multi-datacenter operation

We previously discussed cross-datacenter replication as a use case for multi-leader replication (see “[Multi-Leader Replication](#)” on page 60). Leaderless replication is also suitable for multi-datacenter operation, since it is designed to tolerate conflicting concurrent writes, network interruptions, and latency spikes.

Cassandra and Voldemort implement their multi-datacenter support within the normal leaderless model: the number of replicas  $n$  includes nodes in all datacenters, and in the configuration you can specify how many of the  $n$  replicas you want to have in each datacenter. Each write from a client is sent to all replicas, regardless of datacenter, but the client usually only waits for acknowledgment from a quorum of nodes within its local datacenter so that it is unaffected by delays and interruptions on the cross-datacenter link. The higher-latency writes to other datacenters are often configured to happen asynchronously, although there is some flexibility in the configuration [50, 51].

Riak keeps all communication between clients and database nodes local to one datacenter, so  $n$  describes the number of replicas within one datacenter. Cross-datacenter replication between database clusters happens asynchronously in the background, in a style that is similar to multi-leader replication [52].

## Detecting Concurrent Writes

Dynamo-style databases allow several clients to concurrently write to the same key, which means that conflicts will occur even if strict quorums are used. The situation is similar to multi-leader replication (see “[Handling Write Conflicts](#)” on page 63), although in Dynamo-style databases conflicts can also arise during read repair or hinted handoff.

The problem is that events may arrive in a different order at different nodes, due to variable network delays and partial failures. For example, [Figure 5-12](#) shows two clients, A and B, simultaneously writing to a key X in a three-node datastore:

- Node 1 receives the write from A, but never receives the write from B due to a transient outage.
- Node 2 first receives the write from A, then the write from B.
- Node 3 first receives the write from B, then the write from A.

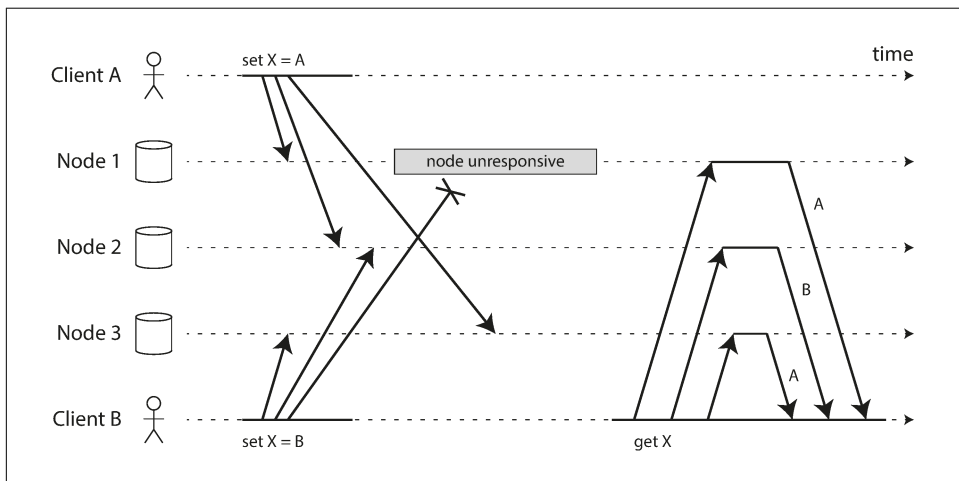

*Figure 5-12. Concurrent writes in a Dynamo-style datastore: there is no well-defined ordering.*

If each node simply overwrote the value for a key whenever it received a write request from a client, the nodes would become permanently inconsistent, as shown by the final *get* request in [Figure 5-12](#): node 2 thinks that the final value of X is B, whereas the other nodes think that the value is A.

In order to become eventually consistent, the replicas should converge toward the same value. How do they do that? One might hope that replicated databases would handle this automatically, but unfortunately most implementations are quite poor: if you want to avoid losing data, you—the application developer—need to know a lot about the internals of your database’s conflict handling.

We briefly touched on some techniques for conflict resolution in “[Handling Write Conflicts](#)” on [page 63](#). Before we wrap up this chapter, let’s explore the issue in a bit more detail.

## Last write wins (discarding concurrent writes)

One approach for achieving eventual convergence is to declare that each replica need only store the most “recent” value and allow “older” values to be overwritten and discarded. Then, as long as we have some way of unambiguously determining which write is more “recent,” and every write is eventually copied to every replica, the replicas will eventually converge to the same value.

As indicated by the quotes around “recent,” this idea is actually quite misleading. In the example of [Figure 5-12](#), neither client knew about the other one when it sent its write requests to the database nodes, so it’s not clear which one happened first. In fact, it doesn’t really make sense to say that either happened “first”: we say the writes are *concurrent*, so their order is undefined.

Even though the writes don’t have a natural ordering, we can force an arbitrary order on them. For example, we can attach a timestamp to each write, pick the biggest timestamp as the most “recent,” and discard any writes with an earlier timestamp. This conflict resolution algorithm, called *last write wins* (LWW), is the only supported conflict resolution method in Cassandra [53], and an optional feature in Riak [35].

LWW achieves the goal of eventual convergence, but at the cost of durability: if there are several concurrent writes to the same key, even if they were all reported as successful to the client (because they were written to  $w$  replicas), only one of the writes will survive and the others will be silently discarded. Moreover, LWW may even drop writes that are not concurrent, as we shall discuss in [“Timestamps for ordering events” on page 109](#).

There are some situations, such as caching, in which lost writes are perhaps acceptable. If losing data is not acceptable, LWW is a poor choice for conflict resolution.

The only safe way of using a database with LWW is to ensure that a key is only written once and thereafter treated as immutable, thus avoiding any concurrent updates to the same key. For example, a recommended way of using Cassandra is to use a UUID as the key, thus giving each write operation a unique key [53].

## The “happens-before” relationship and concurrency

How do we decide whether two operations are concurrent or not? To develop an intuition, let’s look at some examples:

- In [Figure 5-9](#), the two writes are not concurrent: A’s insert *happens before* B’s increment, because the value incremented by B is the value inserted by A. In other words, B’s operation builds upon A’s operation, so B’s operation must have happened later. We also say that B is *causally dependent* on A.

- On the other hand, the two writes in [Figure 5-12](#) are concurrent: when each client starts the operation, it does not know that another client is also performing an operation on the same key. Thus, there is no causal dependency between the operations.

An operation *A* *happens before* another operation *B* if *B* knows about *A*, or depends on *A*, or builds upon *A* in some way. Whether one operation happens before another operation is the key to defining what concurrency means. In fact, we can simply say that two operations are *concurrent* if neither happens before the other (i.e., neither knows about the other) [54].

Thus, whenever you have two operations *A* and *B*, there are three possibilities: either *A* happened before *B*, or *B* happened before *A*, or *A* and *B* are concurrent. What we need is an algorithm to tell us whether two operations are concurrent or not. If one operation happened before another, the later operation should overwrite the earlier operation, but if the operations are concurrent, we have a conflict that needs to be resolved.

### Concurrency, Time, and Relativity

It may seem that two operations should be called concurrent if they occur “at the same time”—but in fact, it is not important whether they literally overlap in time. Because of problems with clocks in distributed systems, it is actually quite difficult to tell whether two things happened at exactly the same time—an issue we will discuss in more detail in [Chapter 8](#).

For defining concurrency, exact time doesn’t matter: we simply call two operations concurrent if they are both unaware of each other, regardless of the physical time at which they occurred. People sometimes make a connection between this principle and the special theory of relativity in physics [54], which introduced the idea that information cannot travel faster than the speed of light. Consequently, two events that occur some distance apart cannot possibly affect each other if the time between the events is shorter than the time it takes light to travel the distance between them.

In computer systems, two operations might be concurrent even though the speed of light would in principle have allowed one operation to affect the other. For example, if the network was slow or interrupted at the time, two operations can occur some time apart and still be concurrent, because the network problems prevented one operation from being able to know about the other.

### Capturing the happens-before relationship

Let’s look at an algorithm that determines whether two operations are concurrent, or whether one happened before another. To keep things simple, let’s start with a data-

base that has only one replica. Once we have worked out how to do this on a single replica, we can generalize the approach to a leaderless database with multiple replicas.

Figure 5-13 shows two clients concurrently adding items to the same shopping cart. (If that example strikes you as too inane, imagine instead two air traffic controllers concurrently adding aircraft to the sector they are tracking.) Initially, the cart is empty. Between them, the clients make five writes to the database:

1. Client 1 adds `milk` to the cart. This is the first write to that key, so the server successfully stores it and assigns it version 1. The server also echoes the value back to the client, along with the version number.
2. Client 2 adds `eggs` to the cart, not knowing that client 1 concurrently added `milk` (client 2 thought that its `eggs` were the only item in the cart). The server assigns version 2 to this write, and stores `eggs` and `milk` as two separate values. It then returns *both* values to the client, along with the version number of 2.
3. Client 1, oblivious to client 2's write, wants to add `flour` to the cart, so it thinks the current cart contents should be `[milk, flour]`. It sends this value to the server, along with the version number 1 that the server gave client 1 previously. The server can tell from the version number that the write of `[milk, flour]` supersedes the prior value of `[milk]` but that it is concurrent with `[eggs]`. Thus, the server assigns version 3 to `[milk, flour]`, overwrites the version 1 value `[milk]`, but keeps the version 2 value `[eggs]` and returns both remaining values to the client.
4. Meanwhile, client 2 wants to add `ham` to the cart, unaware that client 1 just added `flour`. Client 2 received the two values `[milk]` and `[eggs]` from the server in the last response, so the client now merges those values and adds `ham` to form a new value, `[eggs, milk, ham]`. It sends that value to the server, along with the previous version number 2. The server detects that version 2 overwrites `[eggs]` but is concurrent with `[milk, flour]`, so the two remaining values are `[milk, flour]` with version 3, and `[eggs, milk, ham]` with version 4.
5. Finally, client 1 wants to add `bacon`. It previously received `[milk, flour]` and `[eggs]` from the server at version 3, so it merges those, adds `bacon`, and sends the final value `[milk, flour, eggs, bacon]` to the server, along with the version number 3. This overwrites `[milk, flour]` (note that `[eggs]` was already overwritten in the last step) but is concurrent with `[eggs, milk, ham]`, so the server keeps those two concurrent values.



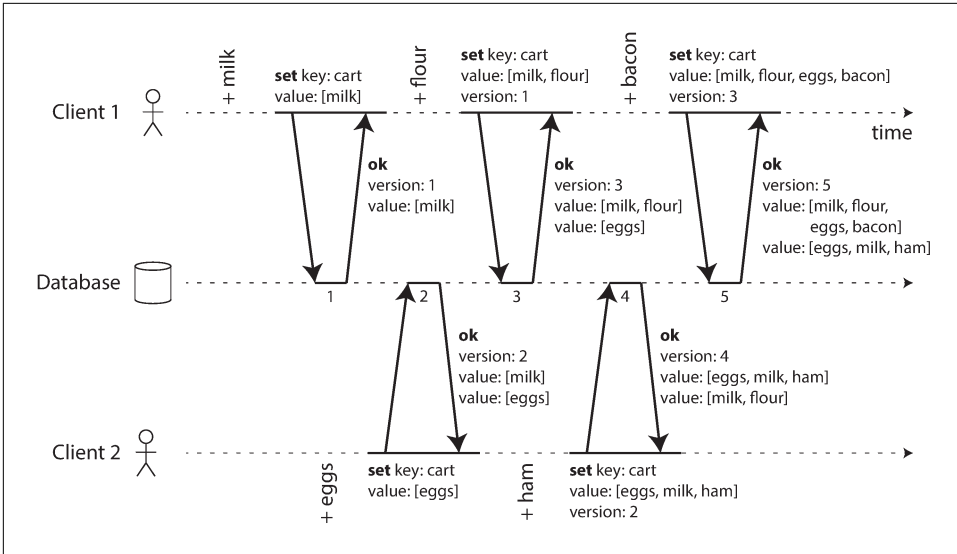

Figure 5-13. Capturing causal dependencies between two clients concurrently editing a shopping cart.

The dataflow between the operations in Figure 5-13 is illustrated graphically in Figure 5-14. The arrows indicate which operation *happened before* which other operation, in the sense that the later operation *knew about* or *depended on* the earlier one. In this example, the clients are never fully up to date with the data on the server, since there is always another operation going on concurrently. But old versions of the value do get overwritten eventually, and no writes are lost.

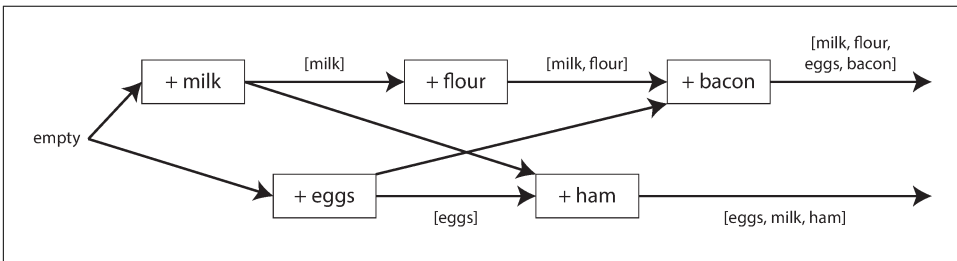

Figure 5-14. Graph of causal dependencies in Figure 5-13.

Note that the server can determine whether two operations are concurrent by looking at the version numbers—it does not need to interpret the value itself (so the value could be any data structure). The algorithm works as follows:

- The server maintains a version number for every key, increments the version number every time that key is written, and stores the new version number along with the value written.
- When a client reads a key, the server returns all values that have not been overwritten, as well as the latest version number. A client must read a key before writing.
- When a client writes a key, it must include the version number from the prior read, and it must merge together all values that it received in the prior read. (The response from a write request can be like a read, returning all current values, which allows us to chain several writes like in the shopping cart example.)
- When the server receives a write with a particular version number, it can overwrite all values with that version number or below (since it knows that they have been merged into the new value), but it must keep all values with a higher version number (because those values are concurrent with the incoming write).

When a write includes the version number from a prior read, that tells us which previous state the write is based on. If you make a write without including a version number, it is concurrent with all other writes, so it will not overwrite anything—it will just be returned as one of the values on subsequent reads.

### Merging concurrently written values

This algorithm ensures that no data is silently dropped, but it unfortunately requires that the clients do some extra work: if several operations happen concurrently, clients have to clean up afterward by merging the concurrently written values. Riak calls these concurrent values *siblings*.

Merging sibling values is essentially the same problem as conflict resolution in multi-leader replication, which we discussed previously (see “[Handling Write Conflicts](#)” on [page 63](#)). A simple approach is to just pick one of the values based on a version number or timestamp (last write wins), but that implies losing data. So, you may need to do something more intelligent in application code.

With the example of a shopping cart, a reasonable approach to merging siblings is to just take the union. In [Figure 5-14](#), the two final siblings are [milk, flour, eggs, bacon] and [eggs, milk, ham]; note that milk and eggs appear in both, even though they were each only written once. The merged value might be something like [milk, flour, eggs, bacon, ham], without duplicates.

However, if you want to allow people to also *remove* things from their carts, and not just add things, then taking the union of siblings may not yield the right result: if you merge two sibling carts and an item has been removed in only one of them, then the removed item will reappear in the union of the siblings [37]. To prevent this prob-

lem, an item cannot simply be deleted from the database when it is removed; instead, the system must leave a marker with an appropriate version number to indicate that the item has been removed when merging siblings. Such a deletion marker is known as a *tombstone*. (We previously saw tombstones in the context of log compaction in “Hash Indexes” on page 4.)

As merging siblings in application code is complex and error-prone, there are some efforts to design data structures that can perform this merging automatically, as discussed in “Automatic Conflict Resolution” on page 66. For example, Riak’s datatype support uses a family of data structures called CRDTs [38, 39, 55] that can automatically merge siblings in sensible ways, including preserving deletions.

## Version vectors

The example in Figure 5-13 used only a single replica. How does the algorithm change when there are multiple replicas, but no leader?

Figure 5-13 uses a single version number to capture dependencies between operations, but that is not sufficient when there are multiple replicas accepting writes concurrently. Instead, we need to use a version number *per replica* as well as *per key*. Each replica increments its own version number when processing a write, and also keeps track of the version numbers it has seen from each of the other replicas. This information indicates which values to overwrite and which values to keep as siblings.

The collection of version numbers from all the replicas is called a *version vector* [56]. A few variants of this idea are in use, but the most interesting is probably the *dotted version vector* [57], which is used in Riak 2.0 [58, 59]. We won’t go into the details, but the way it works is quite similar to what we saw in our cart example.

Like the version numbers in Figure 5-13, version vectors are sent from the database replicas to clients when values are read, and need to be sent back to the database when a value is subsequently written. (Riak encodes the version vector as a string that it calls *causal context*.) The version vector allows the database to distinguish between overwrites and concurrent writes.

Also, like in the single-replica example, the application may need to merge siblings. The version vector structure ensures that it is safe to read from one replica and subsequently write back to another replica. Doing so may result in siblings being created, but no data is lost as long as siblings are merged correctly.



### Version vectors and vector clocks

A *version vector* is sometimes also called a *vector clock*, even though they are not quite the same. The difference is subtle—please see the references for details [57, 60, 61]. In brief, when comparing the state of replicas, version vectors are the right data structure to use.

# Summary

In this chapter we looked at the issue of replication. Replication can serve several purposes:

## *High availability*

Keeping the system running, even when one machine (or several machines, or an entire datacenter) goes down

## *Disconnected operation*

Allowing an application to continue working when there is a network interruption

## *Latency*

Placing data geographically close to users, so that users can interact with it faster

## *Scalability*

Being able to handle a higher volume of reads than a single machine could handle, by performing reads on replicas

Despite being a simple goal—keeping a copy of the same data on several machines—replication turns out to be a remarkably tricky problem. It requires carefully thinking about concurrency and about all the things that can go wrong, and dealing with the consequences of those faults. At a minimum, we need to deal with unavailable nodes and network interruptions (and that’s not even considering the more insidious kinds of fault, such as silent data corruption due to software bugs).

We discussed three main approaches to replication:

## *Single-leader replication*

Clients send all writes to a single node (the leader), which sends a stream of data change events to the other replicas (followers). Reads can be performed on any replica, but reads from followers might be stale.

## *Multi-leader replication*

Clients send each write to one of several leader nodes, any of which can accept writes. The leaders send streams of data change events to each other and to any follower nodes.

## *Leaderless replication*

Clients send each write to several nodes, and read from several nodes in parallel in order to detect and correct nodes with stale data.

Each approach has advantages and disadvantages. Single-leader replication is popular because it is fairly easy to understand and there is no conflict resolution to worry about. Multi-leader and leaderless replication can be more robust in the presence of

faulty nodes, network interruptions, and latency spikes—at the cost of being harder to reason about and providing only very weak consistency guarantees.

Replication can be synchronous or asynchronous, which has a profound effect on the system behavior when there is a fault. Although asynchronous replication can be fast when the system is running smoothly, it's important to figure out what happens when replication lag increases and servers fail. If a leader fails and you promote an asynchronously updated follower to be the new leader, recently committed data may be lost.

We looked at some strange effects that can be caused by replication lag, and we discussed a few consistency models which are helpful for deciding how an application should behave under replication lag:

#### *Read-after-write consistency*

Users should always see data that they submitted themselves.

#### *Monotonic reads*

After users have seen the data at one point in time, they shouldn't later see the data from some earlier point in time.

#### *Consistent prefix reads*

Users should see the data in a state that makes causal sense: for example, seeing a question and its reply in the correct order.

Finally, we discussed the concurrency issues that are inherent in multi-leader and leaderless replication approaches: because such systems allow multiple writes to happen concurrently, conflicts may occur. We examined an algorithm that a database might use to determine whether one operation happened before another, or whether they happened concurrently. We also touched on methods for resolving conflicts by merging together concurrently written values.

In the next chapter we will continue looking at data that is distributed across multiple machines, through the counterpart of replication: splitting a large dataset into *partitions*.

---

## References

- [1] Bruce G. Lindsay, Patricia Griffiths Selinger, C. Galtieri, et al.: “[Notes on Distributed Databases](#),” IBM Research, Research Report RJ2571(33471), July 1979.
- [2] “[Oracle Active Data Guard Real-Time Data Protection and Availability](#),” Oracle White Paper, June 2013.
- [3] “[AlwaysOn Availability Groups](#),” in *SQL Server Books Online*, Microsoft, 2012.

- [4] Lin Qiao, Kapil Surlaker, Shirshanka Das, et al.: “[On Brewing Fresh Espresso: LinkedIn’s Distributed Data Serving Platform](#),” at *ACM International Conference on Management of Data (SIGMOD)*, June 2013.
- [5] Jun Rao: “[Intra-Cluster Replication for Apache Kafka](#),” at *ApacheCon North America*, February 2013.
- [6] “[Highly Available Queues](#),” in *RabbitMQ Server Documentation*, Pivotal Software, Inc., 2014.
- [7] Yoshinori Matsunobu: “[Semi-Synchronous Replication at Facebook](#),” *yoshinori-matsunobu.blogspot.co.uk*, April 1, 2014.
- [8] Robbert van Renesse and Fred B. Schneider: “[Chain Replication for Supporting High Throughput and Availability](#),” at *6th USENIX Symposium on Operating System Design and Implementation (OSDI)*, December 2004.
- [9] Jeff Terrace and Michael J. Freedman: “[Object Storage on CRAQ: High-Throughput Chain Replication for Read-Mostly Workloads](#),” at *USENIX Annual Technical Conference (ATC)*, June 2009.
- [10] Brad Calder, Ju Wang, Aaron Ogus, et al.: “[Windows Azure Storage: A Highly Available Cloud Storage Service with Strong Consistency](#),” at *23rd ACM Symposium on Operating Systems Principles (SOSP)*, October 2011.
- [11] Andrew Wang: “[Windows Azure Storage](#),” *umbrant.com*, February 4, 2016.
- [12] “[Percona Xtrabackup - Documentation](#),” Percona LLC, 2014.
- [13] Jesse Newland: “[GitHub Availability This Week](#),” *github.com*, September 14, 2012.
- [14] Mark Imbriaco: “[Downtime Last Saturday](#),” *github.com*, December 26, 2012.
- [15] John Hugg: “[All in’ with Determinism for Performance and Testing in Distributed Systems](#),” at *Strange Loop*, September 2015.
- [16] Amit Kapila: “[WAL Internals of PostgreSQL](#),” at *PostgreSQL Conference (PGCon)*, May 2012.
- [17] *MySQL Internals Manual*. Oracle, 2014.
- [18] Yogeshwer Sharma, Philippe Ajoux, Petchean Ang, et al.: “[Wormhole: Reliable Pub-Sub to Support Geo-Replicated Internet Services](#),” at *12th USENIX Symposium on Networked Systems Design and Implementation (NSDI)*, May 2015.
- [19] “[Oracle GoldenGate 12c: Real-Time Access to Real-Time Information](#),” Oracle White Paper, October 2013.
- [20] Shirshanka Das, Chavdar Botev, Kapil Surlaker, et al.: “[All Aboard the Data-bus!](#),” at *ACM Symposium on Cloud Computing (SoCC)*, October 2012.

- [21] Greg Sabino Mullane: “[Version 5 of Bucardo Database Replication System](#),” *blog.endpoint.com*, June 23, 2014.
- [22] Werner Vogels: “[Eventually Consistent](#),” *ACM Queue*, volume 6, number 6, pages 14–19, October 2008. doi:10.1145/1466443.1466448
- [23] Douglas B. Terry: “[Replicated Data Consistency Explained Through Baseball](#),” Microsoft Research, Technical Report MSR-TR-2011-137, October 2011.
- [24] Douglas B. Terry, Alan J. Demers, Karin Petersen, et al.: “[Session Guarantees for Weakly Consistent Replicated Data](#),” at *3rd International Conference on Parallel and Distributed Information Systems (PDIS)*, September 1994. doi:10.1109/PDIS.1994.331722
- [25] Terry Pratchett: *Reaper Man: A Discworld Novel*. Victor Gollancz, 1991. ISBN: 978-0-575-04979-6
- [26] “[Tungsten Replicator](#),” *github.com*.
- [27] “[BDR 0.10.0 Documentation](#),” The PostgreSQL Global Development Group, *bdr-project.org*, 2015.
- [28] Robert Hodges: “[If You \\*Must\\* Deploy Multi-Master Replication, Read This First](#),” *scale-out-blog.blogspot.co.uk*, March 30, 2012.
- [29] J. Chris Anderson, Jan Lehnardt, and Noah Slater: *CouchDB: The Definitive Guide*. O’Reilly Media, 2010. ISBN: 978-0-596-15589-6
- [30] AppJet, Inc.: “[Etherpad and EasySync Technical Manual](#),” *github.com*, March 26, 2011.
- [31] John Day-Richter: “[What’s Different About the New Google Docs: Making Collaboration Fast](#),” *drive.googleblog.com*, September 23, 2010.
- [32] Martin Kleppmann and Alastair R. Beresford: “[A Conflict-Free Replicated JSON Datatype](#),” arXiv:1608.03960, August 13, 2016.
- [33] Frazer Clement: “[Eventual Consistency – Detecting Conflicts](#),” *messagepassing.blogspot.co.uk*, October 20, 2011.
- [34] Robert Hodges: “[State of the Art for MySQL Multi-Master Replication](#),” at *Percona Live: MySQL Conference & Expo*, April 2013.
- [35] John Daily: “[Clocks Are Bad, or, Welcome to the Wonderful World of Distributed Systems](#),” *riak.com*, November 12, 2013.
- [36] Riley Berton: “[Is Bi-Directional Replication \(BDR\) in Postgres Transactional?](#),” *sdf.org*, January 4, 2016.

- [37] Giuseppe DeCandia, Deniz Hastorun, Madan Jampani, et al.: “[Dynamo: Amazon’s Highly Available Key-Value Store](#),” at *21st ACM Symposium on Operating Systems Principles (SOSP)*, October 2007.
- [38] Marc Shapiro, Nuno Preguiça, Carlos Baquero, and Marek Zawirski: “[A Comprehensive Study of Convergent and Commutative Replicated Data Types](#),” INRIA Research Report no. 7506, January 2011.
- [39] Sam Elliott: “[CRDTs: An UPDATE \(or Maybe Just a PUT\)](#),” at *RICON West*, October 2013.
- [40] Russell Brown: “[A Bluffers Guide to CRDTs in Riak](#),” *gist.github.com*, October 28, 2013.
- [41] Benjamin Farinier, Thomas Gazagnaire, and Anil Madhavapeddy: “[Mergeable Persistent Data Structures](#),” at *26es Journées Francophones des Langages Applicatifs (JFLA)*, January 2015.
- [42] Chengzheng Sun and Clarence Ellis: “[Operational Transformation in Real-Time Group Editors: Issues, Algorithms, and Achievements](#),” at *ACM Conference on Computer Supported Cooperative Work (CSCW)*, November 1998.
- [43] Lars Hofhansl: “[HBASE-7709: Infinite Loop Possible in Master/Master Replication](#),” *issues.apache.org*, January 29, 2013.
- [44] David K. Gifford: “[Weighted Voting for Replicated Data](#),” at *7th ACM Symposium on Operating Systems Principles (SOSP)*, December 1979. doi:10.1145/800215.806583
- [45] Heidi Howard, Dahlia Malkhi, and Alexander Spiegelman: “[Flexible Paxos: Quorum Intersection Revisited](#),” *arXiv:1608.06696*, August 24, 2016.
- [46] Joseph Blomstedt: “[Re: Absolute Consistency](#),” email to *riak-users* mailing list, *lists.basho.com*, January 11, 2012.
- [47] Joseph Blomstedt: “[Bringing Consistency to Riak](#),” at *RICON West*, October 2012.
- [48] Peter Bailis, Shivaram Venkataraman, Michael J. Franklin, et al.: “[Quantifying Eventual Consistency with PBS](#),” *Communications of the ACM*, volume 57, number 8, pages 93–102, August 2014. doi:10.1145/2632792
- [49] Jonathan Ellis: “[Modern Hinted Handoff](#),” *datastax.com*, December 11, 2012.
- [50] “[Project Voldemort Wiki](#),” *github.com*, 2013.
- [51] “[Apache Cassandra Documentation](#),” Apache Software Foundation, *cassandra.apache.org*.



- [52] “[Riak Enterprise: Multi-Datacenter Replication.](#)” Technical whitepaper, Basho Technologies, Inc., September 2014.
- [53] Jonathan Ellis: “[Why Cassandra Doesn’t Need Vector Clocks,](#)” *datastax.com*, September 2, 2013.
- [54] Leslie Lamport: “[Time, Clocks, and the Ordering of Events in a Distributed System,](#)” *Communications of the ACM*, volume 21, number 7, pages 558–565, July 1978. doi:10.1145/359545.359563
- [55] Joel Jacobson: “[Riak 2.0: Data Types,](#)” *blog.joeljacobson.com*, March 23, 2014.
- [56] D. Stott Parker Jr., Gerald J. Popek, Gerard Rudisin, et al.: “[Detection of Mutual Inconsistency in Distributed Systems,](#)” *IEEE Transactions on Software Engineering*, volume 9, number 3, pages 240–247, May 1983. doi:10.1109/TSE.1983.236733
- [57] Nuno Preguiça, Carlos Baquero, Paulo Sérgio Almeida, et al.: “[Dotted Version Vectors: Logical Clocks for Optimistic Replication,](#)” arXiv:1011.5808, November 26, 2010.
- [58] Sean Cribbs: “[A Brief History of Time in Riak,](#)” at *RICON*, October 2014.
- [59] Russell Brown: “[Vector Clocks Revisited Part 2: Dotted Version Vectors,](#)” *basho.com*, November 10, 2015.
- [60] Carlos Baquero: “[Version Vectors Are Not Vector Clocks,](#)” *haslab.wordpress.com*, July 8, 2011.
- [61] Reinhard Schwarz and Friedemann Mattern: “[Detecting Causal Relationships in Distributed Computations: In Search of the Holy Grail,](#)” *Distributed Computing*, volume 7, number 3, pages 149–174, March 1994. doi:10.1007/BF02277859

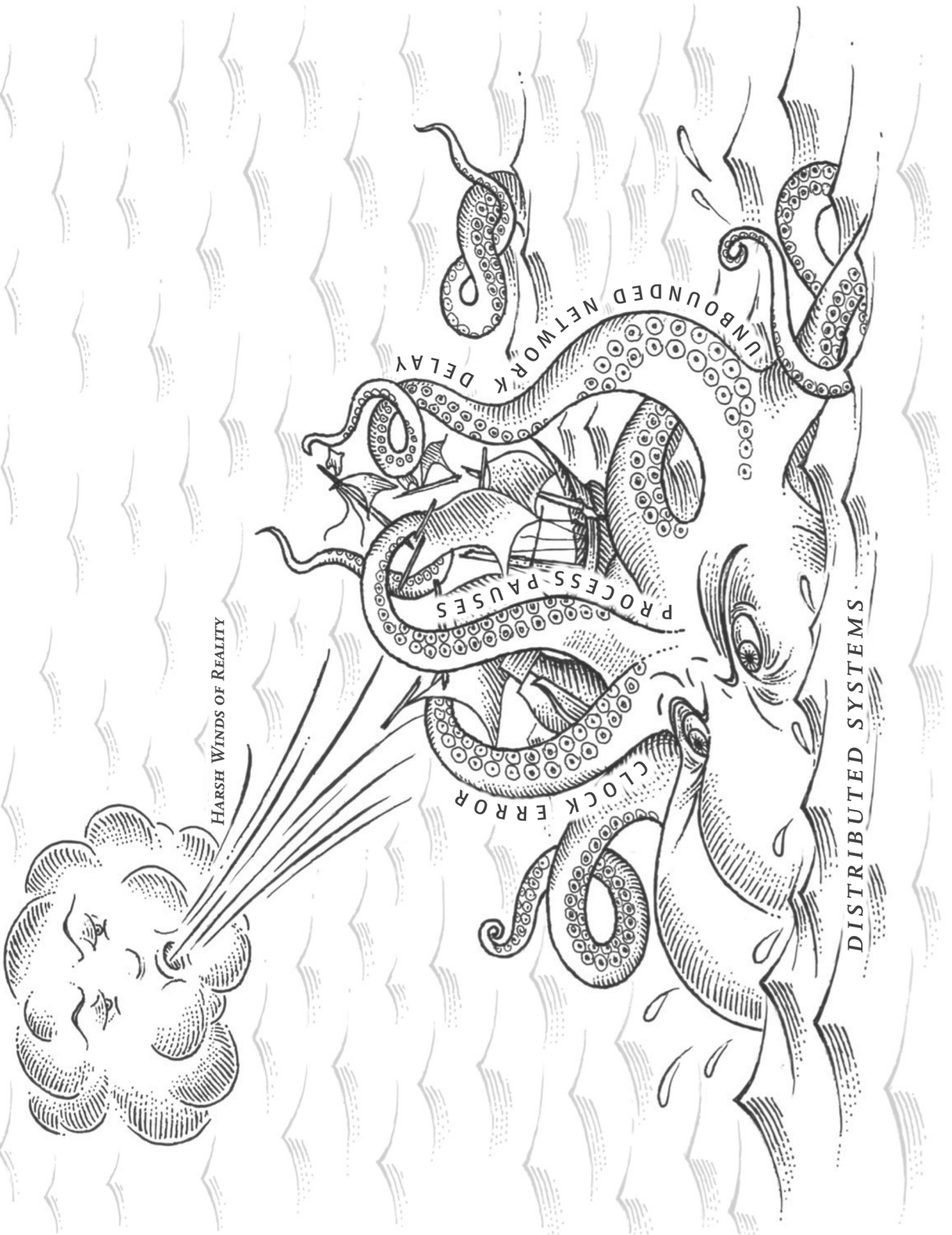

HARSH WINDS OF REALITY

UNBOUNDED NETWORK DELAY

PROCESS PAUSES

CLOCK ERROR

DISTRIBUTED SYSTEMS

---

# The Trouble with Distributed Systems

*Hey I just met you  
The network's laggy  
But here's my data  
So store it maybe*

—Kyle Kingsbury, *Carly Rae Jepsen and the Perils of Network Partitions* (2013)

A recurring theme in the last few chapters has been how systems handle things going wrong. For example, we discussed replica failover (“[Handling Node Outages](#)” on [page 48](#)), replication lag (“[Problems with Replication Lag](#)” on [page 53](#)), and concurrency control for transactions (Chapter 7). As we come to understand various edge cases that can occur in real systems, we get better at handling them.

However, even though we have talked a lot about faults, the last few chapters have still been too optimistic. The reality is even darker. We will now turn our pessimism to the maximum and assume that anything that *can* go wrong *will* go wrong.<sup>i</sup> (Experienced systems operators will tell you that is a reasonable assumption. If you ask nicely, they might tell you some frightening stories while nursing their scars of past battles.)

Working with distributed systems is fundamentally different from writing software on a single computer—and the main difference is that there are lots of new and exciting ways for things to go wrong [1, 2]. In this chapter, we will get a taste of the problems that arise in practice, and an understanding of the things we can and cannot rely on.

In the end, our task as engineers is to build systems that do their job (i.e., meet the guarantees that users are expecting), in spite of everything going wrong. In Chapter 9,

---

i. With one exception: we will assume that faults are *non-Byzantine* (see “[Byzantine Faults](#)” on [page 122](#)).

we will look at some examples of algorithms that can provide such guarantees in a distributed system. But first, in this chapter, we must understand what challenges we are up against.

This chapter is a thoroughly pessimistic and depressing overview of things that may go wrong in a distributed system. We will look into problems with networks (“[Unreliable Networks](#)” on page 95); clocks and timing issues (“[Unreliable Clocks](#)” on page 105); and we’ll discuss to what degree they are avoidable. The consequences of all these issues are disorienting, so we’ll explore how to think about the state of a distributed system and how to reason about things that have happened (“[Knowledge, Truth, and Lies](#)” on page 118).

## Faults and Partial Failures

When you are writing a program on a single computer, it normally behaves in a fairly predictable way: either it works or it doesn’t. Buggy software may give the appearance that the computer is sometimes “having a bad day” (a problem that is often fixed by a reboot), but that is mostly just a consequence of badly written software.

There is no fundamental reason why software on a single computer should be flaky: when the hardware is working correctly, the same operation always produces the same result (it is *deterministic*). If there is a hardware problem (e.g., memory corruption or a loose connector), the consequence is usually a total system failure (e.g., kernel panic, “blue screen of death,” failure to start up). An individual computer with good software is usually either fully functional or entirely broken, but not something in between.

This is a deliberate choice in the design of computers: if an internal fault occurs, we prefer a computer to crash completely rather than returning a wrong result, because wrong results are difficult and confusing to deal with. Thus, computers hide the fuzzy physical reality on which they are implemented and present an idealized system model that operates with mathematical perfection. A CPU instruction always does the same thing; if you write some data to memory or disk, that data remains intact and doesn’t get randomly corrupted. This design goal of always-correct computation goes all the way back to the very first digital computer [3].

When you are writing software that runs on several computers, connected by a network, the situation is fundamentally different. In distributed systems, we are no longer operating in an idealized system model—we have no choice but to confront the messy reality of the physical world. And in the physical world, a remarkably wide range of things can go wrong, as illustrated by this anecdote [4]:

In my limited experience I’ve dealt with long-lived network partitions in a single data center (DC), PDU [power distribution unit] failures, switch failures, accidental power cycles of whole racks, whole-DC backbone failures, whole-DC power failures, and a

hypoglycemic driver smashing his Ford pickup truck into a DC's HVAC [heating, ventilation, and air conditioning] system. And I'm not even an ops guy.

—Coda Hale

In a distributed system, there may well be some parts of the system that are broken in some unpredictable way, even though other parts of the system are working fine. This is known as a *partial failure*. The difficulty is that partial failures are *nondeterministic*: if you try to do anything involving multiple nodes and the network, it may sometimes work and sometimes unpredictably fail. As we shall see, you may not even *know* whether something succeeded or not, as the time it takes for a message to travel across a network is also nondeterministic!

This nondeterminism and possibility of partial failures is what makes distributed systems hard to work with [5].

## Cloud Computing and Supercomputing

There is a spectrum of philosophies on how to build large-scale computing systems:

- At one end of the scale is the field of *high-performance computing* (HPC). Supercomputers with thousands of CPUs are typically used for computationally intensive scientific computing tasks, such as weather forecasting or molecular dynamics (simulating the movement of atoms and molecules).
- At the other extreme is *cloud computing*, which is not very well defined [6] but is often associated with multi-tenant datacenters, commodity computers connected with an IP network (often Ethernet), elastic/on-demand resource allocation, and metered billing.
- Traditional enterprise datacenters lie somewhere between these extremes.

With these philosophies come very different approaches to handling faults. In a supercomputer, a job typically checkpoints the state of its computation to durable storage from time to time. If one node fails, a common solution is to simply stop the entire cluster workload. After the faulty node is repaired, the computation is restarted from the last checkpoint [7, 8]. Thus, a supercomputer is more like a single-node computer than a distributed system: it deals with partial failure by letting it escalate into total failure—if any part of the system fails, just let everything crash (like a kernel panic on a single machine).

In this book we focus on systems for implementing internet services, which usually look very different from supercomputers:

- Many internet-related applications are *online*, in the sense that they need to be able to serve users with low latency at any time. Making the service unavailable—for example, stopping the cluster for repair—is not acceptable. In contrast, off-

line (batch) jobs like weather simulations can be stopped and restarted with fairly low impact.

- Supercomputers are typically built from specialized hardware, where each node is quite reliable, and nodes communicate through shared memory and remote direct memory access (RDMA). On the other hand, nodes in cloud services are built from commodity machines, which can provide equivalent performance at lower cost due to economies of scale, but also have higher failure rates.
- Large datacenter networks are often based on IP and Ethernet, arranged in Clos topologies to provide high bisection bandwidth [9]. Supercomputers often use specialized network topologies, such as multi-dimensional meshes and toruses [10], which yield better performance for HPC workloads with known communication patterns.
- The bigger a system gets, the more likely it is that one of its components is broken. Over time, broken things get fixed and new things break, but in a system with thousands of nodes, it is reasonable to assume that *something* is always broken [7]. When the error handling strategy consists of simply giving up, a large system can end up spending a lot of its time recovering from faults rather than doing useful work [8].
- If the system can tolerate failed nodes and still keep working as a whole, that is a very useful feature for operations and maintenance: for example, you can perform a rolling upgrade (see Chapter 4), restarting one node at a time, while the service continues serving users without interruption. In cloud environments, if one virtual machine is not performing well, you can just kill it and request a new one (hoping that the new one will be faster).
- In a geographically distributed deployment (keeping data geographically close to your users to reduce access latency), communication most likely goes over the internet, which is slow and unreliable compared to local networks. Supercomputers generally assume that all of their nodes are close together.

If we want to make distributed systems work, we must accept the possibility of partial failure and build fault-tolerance mechanisms into the software. In other words, we need to build a reliable system from unreliable components. (As discussed in Chapter 1, there is no such thing as perfect reliability, so we'll need to understand the limits of what we can realistically promise.)

Even in smaller systems consisting of only a few nodes, it's important to think about partial failure. In a small system, it's quite likely that most of the components are working correctly most of the time. However, sooner or later, some part of the system *will* become faulty, and the software will have to somehow handle it. The fault handling must be part of the software design, and you (as operator of the software) need to know what behavior to expect from the software in the case of a fault.

It would be unwise to assume that faults are rare and simply hope for the best. It is important to consider a wide range of possible faults—even fairly unlikely ones—and to artificially create such situations in your testing environment to see what happens. In distributed systems, suspicion, pessimism, and paranoia pay off.

## Building a Reliable System from Unreliable Components

You may wonder whether this makes any sense—intuitively it may seem like a system can only be as reliable as its least reliable component (its *weakest link*). This is not the case: in fact, it is an old idea in computing to construct a more reliable system from a less reliable underlying base [11]. For example:

- Error-correcting codes allow digital data to be transmitted accurately across a communication channel that occasionally gets some bits wrong, for example due to radio interference on a wireless network [12].
- IP (the Internet Protocol) is unreliable: it may drop, delay, duplicate, or reorder packets. TCP (the Transmission Control Protocol) provides a more reliable transport layer on top of IP: it ensures that missing packets are retransmitted, duplicates are eliminated, and packets are reassembled into the order in which they were sent.

Although the system can be more reliable than its underlying parts, there is always a limit to how much more reliable it can be. For example, error-correcting codes can deal with a small number of single-bit errors, but if your signal is swamped by interference, there is a fundamental limit to how much data you can get through your communication channel [13]. TCP can hide packet loss, duplication, and reordering from you, but it cannot magically remove delays in the network.

Although the more reliable higher-level system is not perfect, it's still useful because it takes care of some of the tricky low-level faults, and so the remaining faults are usually easier to reason about and deal with. We will explore this matter further in Chapter 12.

## Unreliable Networks

As discussed in the introduction to Part II, the distributed systems we focus on in this book are *shared-nothing systems*: i.e., a bunch of machines connected by a network. The network is the only way those machines can communicate—we assume that each machine has its own memory and disk, and one machine cannot access another machine's memory or disk (except by making requests to a service over the network).

Shared-nothing is not the only way of building systems, but it has become the dominant approach for building internet services, for several reasons: it's comparatively

cheap because it requires no special hardware, it can make use of commoditized cloud computing services, and it can achieve high reliability through redundancy across multiple geographically distributed datacenters.

The internet and most internal networks in datacenters (often Ethernet) are *asynchronous packet networks*. In this kind of network, one node can send a message (a packet) to another node, but the network gives no guarantees as to when it will arrive, or whether it will arrive at all. If you send a request and expect a response, many things could go wrong (some of which are illustrated in [Figure 8-1](#)):

1. Your request may have been lost (perhaps someone unplugged a network cable).
2. Your request may be waiting in a queue and will be delivered later (perhaps the network or the recipient is overloaded).
3. The remote node may have failed (perhaps it crashed or it was powered down).
4. The remote node may have temporarily stopped responding (perhaps it is experiencing a long garbage collection pause; see [“Process Pauses” on page 113](#)), but it will start responding again later.
5. The remote node may have processed your request, but the response has been lost on the network (perhaps a network switch has been misconfigured).
6. The remote node may have processed your request, but the response has been delayed and will be delivered later (perhaps the network or your own machine is overloaded).

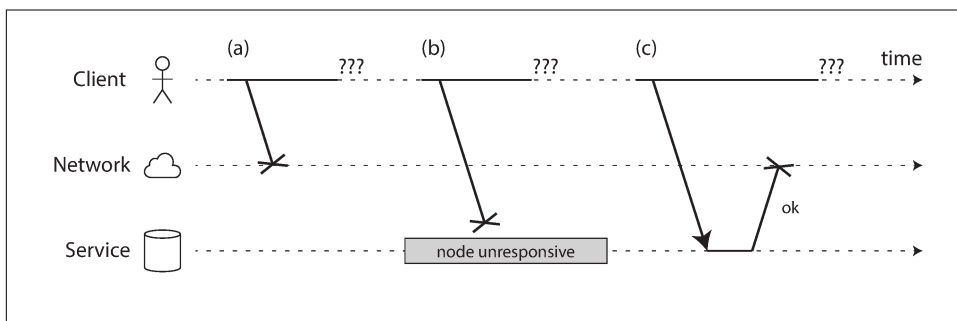

*Figure 8-1. If you send a request and don't get a response, it's not possible to distinguish whether (a) the request was lost, (b) the remote node is down, or (c) the response was lost.*

The sender can't even tell whether the packet was delivered: the only option is for the recipient to send a response message, which may in turn be lost or delayed. These issues are indistinguishable in an asynchronous network: the only information you have is that you haven't received a response yet. If you send a request to another node and don't receive a response, it is *impossible* to tell why.



The usual way of handling this issue is a *timeout*: after some time you give up waiting and assume that the response is not going to arrive. However, when a timeout occurs, you still don't know whether the remote node got your request or not (and if the request is still queued somewhere, it may still be delivered to the recipient, even if the sender has given up on it).

## Network Faults in Practice

We have been building computer networks for decades—one might hope that by now we would have figured out how to make them reliable. However, it seems that we have not yet succeeded.

There are some systematic studies, and plenty of anecdotal evidence, showing that network problems can be surprisingly common, even in controlled environments like a datacenter operated by one company [14]. One study in a medium-sized datacenter found about 12 network faults per month, of which half disconnected a single machine, and half disconnected an entire rack [15]. Another study measured the failure rates of components like top-of-rack switches, aggregation switches, and load balancers [16]. It found that adding redundant networking gear doesn't reduce faults as much as you might hope, since it doesn't guard against human error (e.g., misconfigured switches), which is a major cause of outages.

Public cloud services such as EC2 are notorious for having frequent transient network glitches [14], and well-managed private datacenter networks can be stabler environments. Nevertheless, nobody is immune from network problems: for example, a problem during a software upgrade for a switch could trigger a network topology reconfiguration, during which network packets could be delayed for more than a minute [17]. Sharks might bite undersea cables and damage them [18]. Other surprising faults include a network interface that sometimes drops all inbound packets but sends outbound packets successfully [19]: just because a network link works in one direction doesn't guarantee it's also working in the opposite direction.



### Network partitions

When one part of the network is cut off from the rest due to a network fault, that is sometimes called a *network partition* or *netsplit*. In this book we'll generally stick with the more general term *network fault*, to avoid confusion with partitions (shards) of a storage system, as discussed in Chapter 6.

Even if network faults are rare in your environment, the fact that faults *can* occur means that your software needs to be able to handle them. Whenever any communication happens over a network, it may fail—there is no way around it.

If the error handling of network faults is not defined and tested, arbitrarily bad things could happen: for example, the cluster could become deadlocked and permanently unable to serve requests, even when the network recovers [20], or it could even delete all of your data [21]. If software is put in an unanticipated situation, it may do arbitrary unexpected things.

Handling network faults doesn't necessarily mean *tolerating* them: if your network is normally fairly reliable, a valid approach may be to simply show an error message to users while your network is experiencing problems. However, you do need to know how your software reacts to network problems and ensure that the system can recover from them. It may make sense to deliberately trigger network problems and test the system's response (this is the idea behind Chaos Monkey; see Chapter 1).

## Detecting Faults

Many systems need to automatically detect faulty nodes. For example:

- A load balancer needs to stop sending requests to a node that is dead (i.e., take it *out of rotation*).
- In a distributed database with single-leader replication, if the leader fails, one of the followers needs to be promoted to be the new leader (see “[Handling Node Outages](#)” on page 48).

Unfortunately, the uncertainty about the network makes it difficult to tell whether a node is working or not. In some specific circumstances you might get some feedback to explicitly tell you that something is not working:

- If you can reach the machine on which the node should be running, but no process is listening on the destination port (e.g., because the process crashed), the operating system will helpfully close or refuse TCP connections by sending a RST or FIN packet in reply. However, if the node crashed while it was handling your request, you have no way of knowing how much data was actually processed by the remote node [22].
- If a node process crashed (or was killed by an administrator) but the node's operating system is still running, a script can notify other nodes about the crash so that another node can take over quickly without having to wait for a timeout to expire. For example, HBase does this [23].
- If you have access to the management interface of the network switches in your datacenter, you can query them to detect link failures at a hardware level (e.g., if the remote machine is powered down). This option is ruled out if you're connecting via the internet, or if you're in a shared datacenter with no access to the switches themselves, or if you can't reach the management interface due to a network problem.

- If a router is sure that the IP address you’re trying to connect to is unreachable, it may reply to you with an ICMP Destination Unreachable packet. However, the router doesn’t have a magic failure detection capability either—it is subject to the same limitations as other participants of the network.

Rapid feedback about a remote node being down is useful, but you can’t count on it. Even if TCP acknowledges that a packet was delivered, the application may have crashed before handling it. If you want to be sure that a request was successful, you need a positive response from the application itself [24].

Conversely, if something has gone wrong, you may get an error response at some level of the stack, but in general you have to assume that you will get no response at all. You can retry a few times (TCP retries transparently, but you may also retry at the application level), wait for a timeout to elapse, and eventually declare the node dead if you don’t hear back within the timeout.

## Timeouts and Unbounded Delays

If a timeout is the only sure way of detecting a fault, then how long should the timeout be? There is unfortunately no simple answer.

A long timeout means a long wait until a node is declared dead (and during this time, users may have to wait or see error messages). A short timeout detects faults faster, but carries a higher risk of incorrectly declaring a node dead when in fact it has only suffered a temporary slowdown (e.g., due to a load spike on the node or the network).

Prematurely declaring a node dead is problematic: if the node is actually alive and in the middle of performing some action (for example, sending an email), and another node takes over, the action may end up being performed twice. We will discuss this issue in more detail in [“Knowledge, Truth, and Lies” on page 118](#), and in Chapters 9 and 11.

When a node is declared dead, its responsibilities need to be transferred to other nodes, which places additional load on other nodes and the network. If the system is already struggling with high load, declaring nodes dead prematurely can make the problem worse. In particular, it could happen that the node actually wasn’t dead but only slow to respond due to overload; transferring its load to other nodes can cause a cascading failure (in the extreme case, all nodes declare each other dead, and everything stops working).

Imagine a fictitious system with a network that guaranteed a maximum delay for packets—every packet is either delivered within some time  $d$ , or it is lost, but delivery never takes longer than  $d$ . Furthermore, assume that you can guarantee that a non-failed node always handles a request within some time  $r$ . In this case, you could guarantee that every successful request receives a response within time  $2d + r$ —and if you

don't receive a response within that time, you know that either the network or the remote node is not working. If this was true,  $2d + r$  would be a reasonable timeout to use.

Unfortunately, most systems we work with have neither of those guarantees: asynchronous networks have *unbounded delays* (that is, they try to deliver packets as quickly as possible, but there is no upper limit on the time it may take for a packet to arrive), and most server implementations cannot guarantee that they can handle requests within some maximum time (see “[Response time guarantees](#)” on page 116). For failure detection, it's not sufficient for the system to be fast most of the time: if your timeout is low, it only takes a transient spike in round-trip times to throw the system off-balance.

### Network congestion and queuing

When driving a car, travel times on road networks often vary most due to traffic congestion. Similarly, the variability of packet delays on computer networks is most often due to queuing [25]:

- If several different nodes simultaneously try to send packets to the same destination, the network switch must queue them up and feed them into the destination network link one by one (as illustrated in [Figure 8-2](#)). On a busy network link, a packet may have to wait a while until it can get a slot (this is called *network congestion*). If there is so much incoming data that the switch queue fills up, the packet is dropped, so it needs to be resent—even though the network is functioning fine.
- When a packet reaches the destination machine, if all CPU cores are currently busy, the incoming request from the network is queued by the operating system until the application is ready to handle it. Depending on the load on the machine, this may take an arbitrary length of time.
- In virtualized environments, a running operating system is often paused for tens of milliseconds while another virtual machine uses a CPU core. During this time, the VM cannot consume any data from the network, so the incoming data is queued (buffered) by the virtual machine monitor [26], further increasing the variability of network delays.
- TCP performs *flow control* (also known as *congestion avoidance* or *backpressure*), in which a node limits its own rate of sending in order to avoid overloading a network link or the receiving node [27]. This means additional queuing at the sender before the data even enters the network.

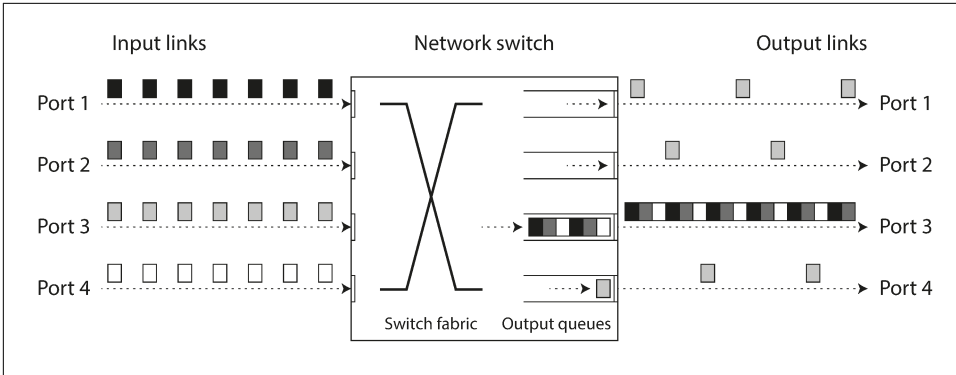

Figure 8-2. If several machines send network traffic to the same destination, its switch queue can fill up. Here, ports 1, 2, and 4 are all trying to send packets to port 3.

Moreover, TCP considers a packet to be lost if it is not acknowledged within some timeout (which is calculated from observed round-trip times), and lost packets are automatically retransmitted. Although the application does not see the packet loss and retransmission, it does see the resulting delay (waiting for the timeout to expire, and then waiting for the retransmitted packet to be acknowledged).

## TCP Versus UDP

Some latency-sensitive applications, such as videoconferencing and Voice over IP (VoIP), use UDP rather than TCP. It's a trade-off between reliability and variability of delays: as UDP does not perform flow control and does not retransmit lost packets, it avoids some of the reasons for variable network delays (although it is still susceptible to switch queues and scheduling delays).

UDP is a good choice in situations where delayed data is worthless. For example, in a VoIP phone call, there probably isn't enough time to retransmit a lost packet before its data is due to be played over the loudspeakers. In this case, there's no point in retransmitting the packet—the application must instead fill the missing packet's time slot with silence (causing a brief interruption in the sound) and move on in the stream. The retry happens at the human layer instead. ("Could you repeat that please? The sound just cut out for a moment.")

All of these factors contribute to the variability of network delays. Queuing delays have an especially wide range when a system is close to its maximum capacity: a system with plenty of spare capacity can easily drain queues, whereas in a highly utilized system, long queues can build up very quickly.

In public clouds and multi-tenant datacenters, resources are shared among many customers: the network links and switches, and even each machine's network inter-

face and CPUs (when running on virtual machines), are shared. Batch workloads such as MapReduce (see Chapter 10) can easily saturate network links. As you have no control over or insight into other customers' usage of the shared resources, network delays can be highly variable if someone near you (a *noisy neighbor*) is using a lot of resources [28, 29].

In such environments, you can only choose timeouts experimentally: measure the distribution of network round-trip times over an extended period, and over many machines, to determine the expected variability of delays. Then, taking into account your application's characteristics, you can determine an appropriate trade-off between failure detection delay and risk of premature timeouts.

Even better, rather than using configured constant timeouts, systems can continually measure response times and their variability (*jitter*), and automatically adjust timeouts according to the observed response time distribution. This can be done with a Phi Accrual failure detector [30], which is used for example in Akka and Cassandra [31]. TCP retransmission timeouts also work similarly [27].

## Synchronous Versus Asynchronous Networks

Distributed systems would be a lot simpler if we could rely on the network to deliver packets with some fixed maximum delay, and not to drop packets. Why can't we solve this at the hardware level and make the network reliable so that the software doesn't need to worry about it?

To answer this question, it's interesting to compare datacenter networks to the traditional fixed-line telephone network (non-cellular, non-VoIP), which is extremely reliable: delayed audio frames and dropped calls are very rare. A phone call requires a constantly low end-to-end latency and enough bandwidth to transfer the audio samples of your voice. Wouldn't it be nice to have similar reliability and predictability in computer networks?

When you make a call over the telephone network, it establishes a *circuit*: a fixed, guaranteed amount of bandwidth is allocated for the call, along the entire route between the two callers. This circuit remains in place until the call ends [32]. For example, an ISDN network runs at a fixed rate of 4,000 frames per second. When a call is established, it is allocated 16 bits of space within each frame (in each direction). Thus, for the duration of the call, each side is guaranteed to be able to send exactly 16 bits of audio data every 250 microseconds [33, 34].

This kind of network is *synchronous*: even as data passes through several routers, it does not suffer from queueing, because the 16 bits of space for the call have already been reserved in the next hop of the network. And because there is no queueing, the maximum end-to-end latency of the network is fixed. We call this a *bounded delay*.

## Can we not simply make network delays predictable?

Note that a circuit in a telephone network is very different from a TCP connection: a circuit is a fixed amount of reserved bandwidth which nobody else can use while the circuit is established, whereas the packets of a TCP connection opportunistically use whatever network bandwidth is available. You can give TCP a variable-sized block of data (e.g., an email or a web page), and it will try to transfer it in the shortest time possible. While a TCP connection is idle, it doesn't use any bandwidth.<sup>ii</sup>

If datacenter networks and the internet were circuit-switched networks, it would be possible to establish a guaranteed maximum round-trip time when a circuit was set up. However, they are not: Ethernet and IP are packet-switched protocols, which suffer from queuing and thus unbounded delays in the network. These protocols do not have the concept of a circuit.

Why do datacenter networks and the internet use packet switching? The answer is that they are optimized for *bursty traffic*. A circuit is good for an audio or video call, which needs to transfer a fairly constant number of bits per second for the duration of the call. On the other hand, requesting a web page, sending an email, or transferring a file doesn't have any particular bandwidth requirement—we just want it to complete as quickly as possible.

If you wanted to transfer a file over a circuit, you would have to guess a bandwidth allocation. If you guess too low, the transfer is unnecessarily slow, leaving network capacity unused. If you guess too high, the circuit cannot be set up (because the network cannot allow a circuit to be created if its bandwidth allocation cannot be guaranteed). Thus, using circuits for bursty data transfers wastes network capacity and makes transfers unnecessarily slow. By contrast, TCP dynamically adapts the rate of data transfer to the available network capacity.

There have been some attempts to build hybrid networks that support both circuit switching and packet switching, such as ATM.<sup>iii</sup> InfiniBand has some similarities [35]: it implements end-to-end flow control at the link layer, which reduces the need for queuing in the network, although it can still suffer from delays due to link congestion [36]. With careful use of *quality of service* (QoS, prioritization and scheduling of packets) and *admission control* (rate-limiting senders), it is possible to emulate circuit switching on packet networks, or provide statistically bounded delay [25, 32].

---

ii. Except perhaps for an occasional keepalive packet, if TCP keepalive is enabled.

iii. *Asynchronous Transfer Mode* (ATM) was a competitor to Ethernet in the 1980s [32], but it didn't gain much adoption outside of telephone network core switches. It has nothing to do with automatic teller machines (also known as cash machines), despite sharing an acronym. Perhaps, in some parallel universe, the internet is based on something like ATM—in that universe, internet video calls are probably a lot more reliable than they are in ours, because they don't suffer from dropped and delayed packets.

## Latency and Resource Utilization

More generally, you can think of variable delays as a consequence of dynamic resource partitioning.

Say you have a wire between two telephone switches that can carry up to 10,000 simultaneous calls. Each circuit that is switched over this wire occupies one of those call slots. Thus, you can think of the wire as a resource that can be shared by up to 10,000 simultaneous users. The resource is divided up in a *static* way: even if you're the only call on the wire right now, and all other 9,999 slots are unused, your circuit is still allocated the same fixed amount of bandwidth as when the wire is fully utilized.

By contrast, the internet shares network bandwidth *dynamically*. Senders push and jostle with each other to get their packets over the wire as quickly as possible, and the network switches decide which packet to send (i.e., the bandwidth allocation) from one moment to the next. This approach has the downside of queuing, but the advantage is that it maximizes utilization of the wire. The wire has a fixed cost, so if you utilize it better, each byte you send over the wire is cheaper.

A similar situation arises with CPUs: if you share each CPU core dynamically between several threads, one thread sometimes has to wait in the operating system's run queue while another thread is running, so a thread can be paused for varying lengths of time. However, this utilizes the hardware better than if you allocated a static number of CPU cycles to each thread (see [“Response time guarantees” on page 116](#)). Better hardware utilization is also a significant motivation for using virtual machines.

Latency guarantees are achievable in certain environments, if resources are statically partitioned (e.g., dedicated hardware and exclusive bandwidth allocations). However, it comes at the cost of reduced utilization—in other words, it is more expensive. On the other hand, multi-tenancy with dynamic resource partitioning provides better utilization, so it is cheaper, but it has the downside of variable delays.

Variable delays in networks are not a law of nature, but simply the result of a cost/benefit trade-off.

However, such quality of service is currently not enabled in multi-tenant datacenters and public clouds, or when communicating via the internet.<sup>iv</sup> Currently deployed technology does not allow us to make any guarantees about delays or reliability of the network: we have to assume that network congestion, queuing, and unbounded

---

iv. Peering agreements between internet service providers and the establishment of routes through the Border Gateway Protocol (BGP), bear closer resemblance to circuit switching than IP itself. At this level, it is possible to buy dedicated bandwidth. However, internet routing operates at the level of networks, not individual connections between hosts, and at a much longer timescale.



delays will happen. Consequently, there's no "correct" value for timeouts—they need to be determined experimentally.

## Unreliable Clocks

Clocks and time are important. Applications depend on clocks in various ways to answer questions like the following:

1. Has this request timed out yet?
2. What's the 99th percentile response time of this service?
3. How many queries per second did this service handle on average in the last five minutes?
4. How long did the user spend on our site?
5. When was this article published?
6. At what date and time should the reminder email be sent?
7. When does this cache entry expire?
8. What is the timestamp on this error message in the log file?

Examples 1–4 measure *durations* (e.g., the time interval between a request being sent and a response being received), whereas examples 5–8 describe *points in time* (events that occur on a particular date, at a particular time).

In a distributed system, time is a tricky business, because communication is not instantaneous: it takes time for a message to travel across the network from one machine to another. The time when a message is received is always later than the time when it is sent, but due to variable delays in the network, we don't know how much later. This fact sometimes makes it difficult to determine the order in which things happened when multiple machines are involved.

Moreover, each machine on the network has its own clock, which is an actual hardware device: usually a quartz crystal oscillator. These devices are not perfectly accurate, so each machine has its own notion of time, which may be slightly faster or slower than on other machines. It is possible to synchronize clocks to some degree: the most commonly used mechanism is the Network Time Protocol (NTP), which allows the computer clock to be adjusted according to the time reported by a group of servers [37]. The servers in turn get their time from a more accurate time source, such as a GPS receiver.

## Monotonic Versus Time-of-Day Clocks

Modern computers have at least two different kinds of clocks: a *time-of-day clock* and a *monotonic clock*. Although they both measure time, it is important to distinguish the two, since they serve different purposes.

### Time-of-day clocks

A time-of-day clock does what you intuitively expect of a clock: it returns the current date and time according to some calendar (also known as *wall-clock time*). For example, `clock_gettime(CLOCK_REALTIME)` on Linux<sup>v</sup> and `System.currentTimeMillis()` in Java return the number of seconds (or milliseconds) since the *epoch*: midnight UTC on January 1, 1970, according to the Gregorian calendar, not counting leap seconds. Some systems use other dates as their reference point.

Time-of-day clocks are usually synchronized with NTP, which means that a timestamp from one machine (ideally) means the same as a timestamp on another machine. However, time-of-day clocks also have various oddities, as described in the next section. In particular, if the local clock is too far ahead of the NTP server, it may be forcibly reset and appear to jump back to a previous point in time. These jumps, as well as similar jumps caused by leap seconds, make time-of-day clocks unsuitable for measuring elapsed time [38].

Time-of-day clocks have also historically had quite a coarse-grained resolution, e.g., moving forward in steps of 10 ms on older Windows systems [39]. On recent systems, this is less of a problem.

### Monotonic clocks

A monotonic clock is suitable for measuring a duration (time interval), such as a timeout or a service's response time: `clock_gettime(CLOCK_MONOTONIC)` on Linux and `System.nanoTime()` in Java are monotonic clocks, for example. The name comes from the fact that they are guaranteed to always move forward (whereas a time-of-day clock may jump back in time).

You can check the value of the monotonic clock at one point in time, do something, and then check the clock again at a later time. The *difference* between the two values tells you how much time elapsed between the two checks. However, the *absolute* value of the clock is meaningless: it might be the number of nanoseconds since the computer was started, or something similarly arbitrary. In particular, it makes no sense to compare monotonic clock values from two different computers, because they don't mean the same thing.

---

v. Although the clock is called *real-time*, it has nothing to do with real-time operating systems, as discussed in “Response time guarantees” on page 116.

On a server with multiple CPU sockets, there may be a separate timer per CPU, which is not necessarily synchronized with other CPUs. Operating systems compensate for any discrepancy and try to present a monotonic view of the clock to application threads, even as they are scheduled across different CPUs. However, it is wise to take this guarantee of monotonicity with a pinch of salt [40].

NTP may adjust the frequency at which the monotonic clock moves forward (this is known as *slewing* the clock) if it detects that the computer's local quartz is moving faster or slower than the NTP server. By default, NTP allows the clock rate to be speeded up or slowed down by up to 0.05%, but NTP cannot cause the monotonic clock to jump forward or backward. The resolution of monotonic clocks is usually quite good: on most systems they can measure time intervals in microseconds or less.

In a distributed system, using a monotonic clock for measuring elapsed time (e.g., timeouts) is usually fine, because it doesn't assume any synchronization between different nodes' clocks and is not sensitive to slight inaccuracies of measurement.

## Clock Synchronization and Accuracy

Monotonic clocks don't need synchronization, but time-of-day clocks need to be set according to an NTP server or other external time source in order to be useful. Unfortunately, our methods for getting a clock to tell the correct time aren't nearly as reliable or accurate as you might hope—hardware clocks and NTP can be fickle beasts. To give just a few examples:

- The quartz clock in a computer is not very accurate: it *drifts* (runs faster or slower than it should). Clock drift varies depending on the temperature of the machine. Google assumes a clock drift of 200 ppm (parts per million) for its servers [41], which is equivalent to 6 ms drift for a clock that is resynchronized with a server every 30 seconds, or 17 seconds drift for a clock that is resynchronized once a day. This drift limits the best possible accuracy you can achieve, even if everything is working correctly.
- If a computer's clock differs too much from an NTP server, it may refuse to synchronize, or the local clock will be forcibly reset [37]. Any applications observing the time before and after this reset may see time go backward or suddenly jump forward.
- If a node is accidentally firewalled off from NTP servers, the misconfiguration may go unnoticed for some time. Anecdotal evidence suggests that this does happen in practice.
- NTP synchronization can only be as good as the network delay, so there is a limit to its accuracy when you're on a congested network with variable packet delays. One experiment showed that a minimum error of 35 ms is achievable when synchronizing over the internet [42], though occasional spikes in network delay lead

to errors of around a second. Depending on the configuration, large network delays can cause the NTP client to give up entirely.

- Some NTP servers are wrong or misconfigured, reporting time that is off by hours [43, 44]. NTP clients are quite robust, because they query several servers and ignore outliers. Nevertheless, it's somewhat worrying to bet the correctness of your systems on the time that you were told by a stranger on the internet.
- Leap seconds result in a minute that is 59 seconds or 61 seconds long, which messes up timing assumptions in systems that are not designed with leap seconds in mind [45]. The fact that leap seconds have crashed many large systems [38, 46] shows how easy it is for incorrect assumptions about clocks to sneak into a system. The best way of handling leap seconds may be to make NTP servers “lie,” by performing the leap second adjustment gradually over the course of a day (this is known as *smearing*) [47, 48], although actual NTP server behavior varies in practice [49].
- In virtual machines, the hardware clock is virtualized, which raises additional challenges for applications that need accurate timekeeping [50]. When a CPU core is shared between virtual machines, each VM is paused for tens of milliseconds while another VM is running. From an application's point of view, this pause manifests itself as the clock suddenly jumping forward [26].
- If you run software on devices that you don't fully control (e.g., mobile or embedded devices), you probably cannot trust the device's hardware clock at all. Some users deliberately set their hardware clock to an incorrect date and time, for example to circumvent timing limitations in games. As a result, the clock might be set to a time wildly in the past or the future.

It is possible to achieve very good clock accuracy if you care about it sufficiently to invest significant resources. For example, the MiFID II draft European regulation for financial institutions requires all high-frequency trading funds to synchronize their clocks to within 100 microseconds of UTC, in order to help debug market anomalies such as “flash crashes” and to help detect market manipulation [51].

Such accuracy can be achieved using GPS receivers, the Precision Time Protocol (PTP) [52], and careful deployment and monitoring. However, it requires significant effort and expertise, and there are plenty of ways clock synchronization can go wrong. If your NTP daemon is misconfigured, or a firewall is blocking NTP traffic, the clock error due to drift can quickly become large.

## Relying on Synchronized Clocks

The problem with clocks is that while they seem simple and easy to use, they have a surprising number of pitfalls: a day may not have exactly 86,400 seconds, time-of-day

clocks may move backward in time, and the time on one node may be quite different from the time on another node.

Earlier in this chapter we discussed networks dropping and arbitrarily delaying packets. Even though networks are well behaved most of the time, software must be designed on the assumption that the network will occasionally be faulty, and the software must handle such faults gracefully. The same is true with clocks: although they work quite well most of the time, robust software needs to be prepared to deal with incorrect clocks.

Part of the problem is that incorrect clocks easily go unnoticed. If a machine's CPU is defective or its network is misconfigured, it most likely won't work at all, so it will quickly be noticed and fixed. On the other hand, if its quartz clock is defective or its NTP client is misconfigured, most things will seem to work fine, even though its clock gradually drifts further and further away from reality. If some piece of software is relying on an accurately synchronized clock, the result is more likely to be silent and subtle data loss than a dramatic crash [53, 54].

Thus, if you use software that requires synchronized clocks, it is essential that you also carefully monitor the clock offsets between all the machines. Any node whose clock drifts too far from the others should be declared dead and removed from the cluster. Such monitoring ensures that you notice the broken clocks before they can cause too much damage.

### Timestamps for ordering events

Let's consider one particular situation in which it is tempting, but dangerous, to rely on clocks: ordering of events across multiple nodes. For example, if two clients write to a distributed database, who got there first? Which write is the more recent one?

**Figure 8-3** illustrates a dangerous use of time-of-day clocks in a database with multi-leader replication (the example is similar to **Figure 5-9**). Client A writes  $x = 1$  on node 1; the write is replicated to node 3; client B increments  $x$  on node 3 (we now have  $x = 2$ ); and finally, both writes are replicated to node 2.

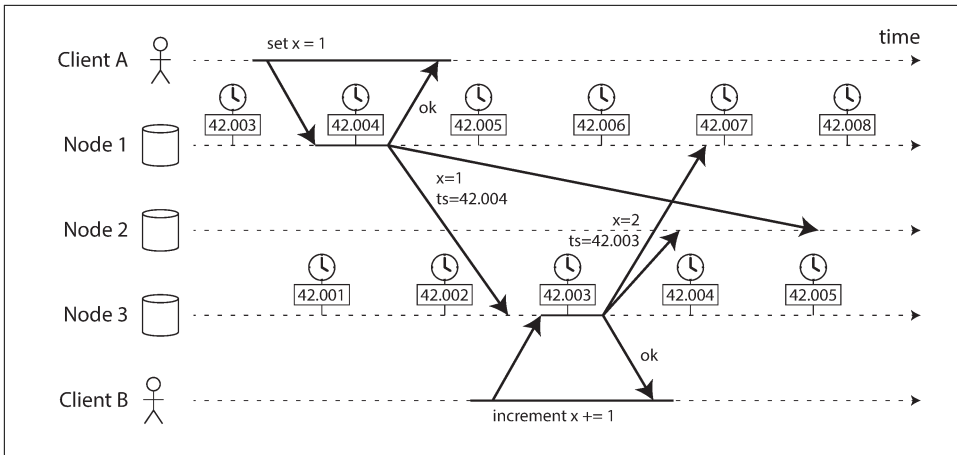

Figure 8-3. The write by client B is causally later than the write by client A, but B’s write has an earlier timestamp.

In [Figure 8-3](#), when a write is replicated to other nodes, it is tagged with a timestamp according to the time-of-day clock on the node where the write originated. The clock synchronization is very good in this example: the skew between node 1 and node 3 is less than 3 ms, which is probably better than you can expect in practice.

Nevertheless, the timestamps in [Figure 8-3](#) fail to order the events correctly: the write  $x = 1$  has a timestamp of 42.004 seconds, but the write  $x = 2$  has a timestamp of 42.003 seconds, even though  $x = 2$  occurred unambiguously later. When node 2 receives these two events, it will incorrectly conclude that  $x = 1$  is the more recent value and drop the write  $x = 2$ . In effect, client B’s increment operation will be lost.

This conflict resolution strategy is called *last write wins* (LWW), and it is widely used in both multi-leader replication and leaderless databases such as Cassandra [53] and Riak [54] (see [“Last write wins \(discarding concurrent writes\)”](#) on page 78). Some implementations generate timestamps on the client rather than the server, but this doesn’t change the fundamental problems with LWW:

- Database writes can mysteriously disappear: a node with a lagging clock is unable to overwrite values previously written by a node with a fast clock until the clock skew between the nodes has elapsed [54, 55]. This scenario can cause arbitrary amounts of data to be silently dropped without any error being reported to the application.
- LWW cannot distinguish between writes that occurred sequentially in quick succession (in [Figure 8-3](#), client B’s increment definitely occurs *after* client A’s write) and writes that were truly concurrent (neither writer was aware of the other). Additional causality tracking mechanisms, such as version vectors, are

needed in order to prevent violations of causality (see “[Detecting Concurrent Writes](#)” on page 76).

- It is possible for two nodes to independently generate writes with the same timestamp, especially when the clock only has millisecond resolution. An additional tiebreaker value (which can simply be a large random number) is required to resolve such conflicts, but this approach can also lead to violations of causality [53].

Thus, even though it is tempting to resolve conflicts by keeping the most “recent” value and discarding others, it’s important to be aware that the definition of “recent” depends on a local time-of-day clock, which may well be incorrect. Even with tightly NTP-synchronized clocks, you could send a packet at timestamp 100 ms (according to the sender’s clock) and have it arrive at timestamp 99 ms (according to the recipient’s clock)—so it appears as though the packet arrived before it was sent, which is impossible.

Could NTP synchronization be made accurate enough that such incorrect orderings cannot occur? Probably not, because NTP’s synchronization accuracy is itself limited by the network round-trip time, in addition to other sources of error such as quartz drift. For correct ordering, you would need the clock source to be significantly more accurate than the thing you are measuring (namely network delay).

So-called *logical clocks* [56, 57], which are based on incrementing counters rather than an oscillating quartz crystal, are a safer alternative for ordering events (see “[Detecting Concurrent Writes](#)” on page 76). Logical clocks do not measure the time of day or the number of seconds elapsed, only the relative ordering of events (whether one event happened before or after another). In contrast, time-of-day and monotonic clocks, which measure actual elapsed time, are also known as *physical clocks*. We’ll look at ordering a bit more in Chapter 9.

### **Clock readings have a confidence interval**

You may be able to read a machine’s time-of-day clock with microsecond or even nanosecond resolution. But even if you can get such a fine-grained measurement, that doesn’t mean the value is actually accurate to such precision. In fact, it most likely is not—as mentioned previously, the drift in an imprecise quartz clock can easily be several milliseconds, even if you synchronize with an NTP server on the local network every minute. With an NTP server on the public internet, the best possible accuracy is probably to the tens of milliseconds, and the error may easily spike to over 100 ms when there is network congestion [57].

Thus, it doesn’t make sense to think of a clock reading as a point in time—it is more like a range of times, within a confidence interval: for example, a system may be 95% confident that the time now is between 10.3 and 10.5 seconds past the minute, but it

doesn't know any more precisely than that [58]. If we only know the time +/- 100 ms, the microsecond digits in the timestamp are essentially meaningless.

The uncertainty bound can be calculated based on your time source. If you have a GPS receiver or atomic (caesium) clock directly attached to your computer, the expected error range is reported by the manufacturer. If you're getting the time from a server, the uncertainty is based on the expected quartz drift since your last sync with the server, plus the NTP server's uncertainty, plus the network round-trip time to the server (to a first approximation, and assuming you trust the server).

Unfortunately, most systems don't expose this uncertainty: for example, when you call `clock_gettime()`, the return value doesn't tell you the expected error of the timestamp, so you don't know if its confidence interval is five milliseconds or five years.

An interesting exception is Google's *TrueTime* API in Spanner [41], which explicitly reports the confidence interval on the local clock. When you ask it for the current time, you get back two values: [*earliest*, *latest*], which are the *earliest possible* and the *latest possible* timestamp. Based on its uncertainty calculations, the clock knows that the actual current time is somewhere within that interval. The width of the interval depends, among other things, on how long it has been since the local quartz clock was last synchronized with a more accurate clock source.

### Synchronized clocks for global snapshots

In Chapter 7 we discussed *snapshot isolation*, which is a very useful feature in databases that need to support both small, fast read-write transactions and large, long-running read-only transactions (e.g., for backups or analytics). It allows read-only transactions to see the database in a consistent state at a particular point in time, without locking and interfering with read-write transactions.

The most common implementation of snapshot isolation requires a monotonically increasing transaction ID. If a write happened later than the snapshot (i.e., the write has a greater transaction ID than the snapshot), that write is invisible to the snapshot transaction. On a single-node database, a simple counter is sufficient for generating transaction IDs.

However, when a database is distributed across many machines, potentially in multiple datacenters, a global, monotonically increasing transaction ID (across all partitions) is difficult to generate, because it requires coordination. The transaction ID must reflect causality: if transaction B reads a value that was written by transaction A, then B must have a higher transaction ID than A—otherwise, the snapshot would not



be consistent. With lots of small, rapid transactions, creating transaction IDs in a distributed system becomes an untenable bottleneck.<sup>vi</sup>

Can we use the timestamps from synchronized time-of-day clocks as transaction IDs? If we could get the synchronization good enough, they would have the right properties: later transactions have a higher timestamp. The problem, of course, is the uncertainty about clock accuracy.

Spanner implements snapshot isolation across datacenters in this way [59, 60]. It uses the clock's confidence interval as reported by the TrueTime API, and is based on the following observation: if you have two confidence intervals, each consisting of an earliest and latest possible timestamp ( $A = [A_{\text{earliest}}, A_{\text{latest}}]$  and  $B = [B_{\text{earliest}}, B_{\text{latest}}]$ ), and those two intervals do not overlap (i.e.,  $A_{\text{earliest}} < A_{\text{latest}} < B_{\text{earliest}} < B_{\text{latest}}$ ), then B definitely happened after A—there can be no doubt. Only if the intervals overlap are we unsure in which order A and B happened.

In order to ensure that transaction timestamps reflect causality, Spanner deliberately waits for the length of the confidence interval before committing a read-write transaction. By doing so, it ensures that any transaction that may read the data is at a sufficiently later time, so their confidence intervals do not overlap. In order to keep the wait time as short as possible, Spanner needs to keep the clock uncertainty as small as possible; for this purpose, Google deploys a GPS receiver or atomic clock in each datacenter, allowing clocks to be synchronized to within about 7 ms [41].

Using clock synchronization for distributed transaction semantics is an area of active research [57, 61, 62]. These ideas are interesting, but they have not yet been implemented in mainstream databases outside of Google.

## Process Pauses

Let's consider another example of dangerous clock use in a distributed system. Say you have a database with a single leader per partition. Only the leader is allowed to accept writes. How does a node know that it is still leader (that it hasn't been declared dead by the others), and that it may safely accept writes?

One option is for the leader to obtain a *lease* from the other nodes, which is similar to a lock with a timeout [63]. Only one node can hold the lease at any one time—thus, when a node obtains a lease, it knows that it is the leader for some amount of time, until the lease expires. In order to remain leader, the node must periodically renew

---

vi. There are distributed sequence number generators, such as Twitter's Snowflake, that generate *approximately* monotonically increasing unique IDs in a scalable way (e.g., by allocating blocks of the ID space to different nodes). However, they typically cannot guarantee an ordering that is consistent with causality, because the timescale at which blocks of IDs are assigned is longer than the timescale of database reads and writes. See also Chapter 9.

the lease before it expires. If the node fails, it stops renewing the lease, so another node can take over when it expires.

You can imagine the request-handling loop looking something like this:

```
while (true) {
    request = getIncomingRequest();

    // Ensure that the lease always has at least 10 seconds remaining
    if (lease.expiryTimeMillis - System.currentTimeMillis() < 10000) {
        lease = lease.renew();
    }

    if (lease.isValid()) {
        process(request);
    }
}
```

What’s wrong with this code? Firstly, it’s relying on synchronized clocks: the expiry time on the lease is set by a different machine (where the expiry may be calculated as the current time plus 30 seconds, for example), and it’s being compared to the local system clock. If the clocks are out of sync by more than a few seconds, this code will start doing strange things.

Secondly, even if we change the protocol to only use the local monotonic clock, there is another problem: the code assumes that very little time passes between the point that it checks the time (`System.currentTimeMillis()`) and the time when the request is processed (`process(request)`). Normally this code runs very quickly, so the 10 second buffer is more than enough to ensure that the lease doesn’t expire in the middle of processing a request.

However, what if there is an unexpected pause in the execution of the program? For example, imagine the thread stops for 15 seconds around the line `lease.isValid()` before finally continuing. In that case, it’s likely that the lease will have expired by the time the request is processed, and another node has already taken over as leader. However, there is nothing to tell this thread that it was paused for so long, so this code won’t notice that the lease has expired until the next iteration of the loop—by which time it may have already done something unsafe by processing the request.

Is it crazy to assume that a thread might be paused for so long? Unfortunately not. There are various reasons why this could happen:

- Many programming language runtimes (such as the Java Virtual Machine) have a *garbage collector* (GC) that occasionally needs to stop all running threads. These “*stop-the-world*” GC pauses have sometimes been known to last for several minutes [64]! Even so-called “concurrent” garbage collectors like the HotSpot JVM’s CMS cannot fully run in parallel with the application code—even they need to stop the world from time to time [65]. Although the pauses can often be

reduced by changing allocation patterns or tuning GC settings [66], we must assume the worst if we want to offer robust guarantees.

- In virtualized environments, a virtual machine can be *suspended* (pausing the execution of all processes and saving the contents of memory to disk) and *resumed* (restoring the contents of memory and continuing execution). This pause can occur at any time in a process's execution and can last for an arbitrary length of time. This feature is sometimes used for *live migration* of virtual machines from one host to another without a reboot, in which case the length of the pause depends on the rate at which processes are writing to memory [67].
- On end-user devices such as laptops, execution may also be suspended and resumed arbitrarily, e.g., when the user closes the lid of their laptop.
- When the operating system context-switches to another thread, or when the hypervisor switches to a different virtual machine (when running in a virtual machine), the currently running thread can be paused at any arbitrary point in the code. In the case of a virtual machine, the CPU time spent in other virtual machines is known as *steal time*. If the machine is under heavy load—i.e., if there is a long queue of threads waiting to run—it may take some time before the paused thread gets to run again.
- If the application performs synchronous disk access, a thread may be paused waiting for a slow disk I/O operation to complete [68]. In many languages, disk access can happen surprisingly, even if the code doesn't explicitly mention file access—for example, the Java classloader lazily loads class files when they are first used, which could happen at any time in the program execution. I/O pauses and GC pauses may even conspire to combine their delays [69]. If the disk is actually a network filesystem or network block device (such as Amazon's EBS), the I/O latency is further subject to the variability of network delays [29].
- If the operating system is configured to allow *swapping to disk* (*paging*), a simple memory access may result in a page fault that requires a page from disk to be loaded into memory. The thread is paused while this slow I/O operation takes place. If memory pressure is high, this may in turn require a different page to be swapped out to disk. In extreme circumstances, the operating system may spend most of its time swapping pages in and out of memory and getting little actual work done (this is known as *thrashing*). To avoid this problem, paging is often disabled on server machines (if you would rather kill a process to free up memory than risk thrashing).
- A Unix process can be paused by sending it the SIGSTOP signal, for example by pressing Ctrl-Z in a shell. This signal immediately stops the process from getting any more CPU cycles until it is resumed with SIGCONT, at which point it continues running where it left off. Even if your environment does not normally use SIGSTOP, it might be sent accidentally by an operations engineer.

All of these occurrences can *preempt* the running thread at any point and resume it at some later time, without the thread even noticing. The problem is similar to making multi-threaded code on a single machine thread-safe: you can't assume anything about timing, because arbitrary context switches and parallelism may occur.

When writing multi-threaded code on a single machine, we have fairly good tools for making it thread-safe: mutexes, semaphores, atomic counters, lock-free data structures, blocking queues, and so on. Unfortunately, these tools don't directly translate to distributed systems, because a distributed system has no shared memory—only messages sent over an unreliable network.

A node in a distributed system must assume that its execution can be paused for a significant length of time at any point, even in the middle of a function. During the pause, the rest of the world keeps moving and may even declare the paused node dead because it's not responding. Eventually, the paused node may continue running, without even noticing that it was asleep until it checks its clock sometime later.

### Response time guarantees

In many programming languages and operating systems, threads and processes may pause for an unbounded amount of time, as discussed. Those reasons for pausing *can* be eliminated if you try hard enough.

Some software runs in environments where a failure to respond within a specified time can cause serious damage: computers that control aircraft, rockets, robots, cars, and other physical objects must respond quickly and predictably to their sensor inputs. In these systems, there is a specified *deadline* by which the software must respond; if it doesn't meet the deadline, that may cause a failure of the entire system. These are so-called *hard real-time* systems.



#### Is real-time really real?

In embedded systems, *real-time* means that a system is carefully designed and tested to meet specified timing guarantees in all circumstances. This meaning is in contrast to the more vague use of the term *real-time* on the web, where it describes servers pushing data to clients and stream processing without hard response time constraints (see Chapter 11).

For example, if your car's onboard sensors detect that you are currently experiencing a crash, you wouldn't want the release of the airbag to be delayed due to an inopportune GC pause in the airbag release system.

Providing real-time guarantees in a system requires support from all levels of the software stack: a *real-time operating system* (RTOS) that allows processes to be scheduled with a guaranteed allocation of CPU time in specified intervals is needed; library

functions must document their worst-case execution times; dynamic memory allocation may be restricted or disallowed entirely (real-time garbage collectors exist, but the application must still ensure that it doesn't give the GC too much work to do); and an enormous amount of testing and measurement must be done to ensure that guarantees are being met.

All of this requires a large amount of additional work and severely restricts the range of programming languages, libraries, and tools that can be used (since most languages and tools do not provide real-time guarantees). For these reasons, developing real-time systems is very expensive, and they are most commonly used in safety-critical embedded devices. Moreover, “real-time” is not the same as “high-performance”—in fact, real-time systems may have lower throughput, since they have to prioritize timely responses above all else (see also “[Latency and Resource Utilization](#)” on page 104).

For most server-side data processing systems, real-time guarantees are simply not economical or appropriate. Consequently, these systems must suffer the pauses and clock instability that come from operating in a non-real-time environment.

### **Limiting the impact of garbage collection**

The negative effects of process pauses can be mitigated without resorting to expensive real-time scheduling guarantees. Language runtimes have some flexibility around when they schedule garbage collections, because they can track the rate of object allocation and the remaining free memory over time.

An emerging idea is to treat GC pauses like brief planned outages of a node, and to let other nodes handle requests from clients while one node is collecting its garbage. If the runtime can warn the application that a node soon requires a GC pause, the application can stop sending new requests to that node, wait for it to finish processing outstanding requests, and then perform the GC while no requests are in progress. This trick hides GC pauses from clients and reduces the high percentiles of response time [70, 71]. Some latency-sensitive financial trading systems [72] use this approach.

A variant of this idea is to use the garbage collector only for short-lived objects (which are fast to collect) and to restart processes periodically, before they accumulate enough long-lived objects to require a full GC of long-lived objects [65, 73]. One node can be restarted at a time, and traffic can be shifted away from the node before the planned restart, like in a rolling upgrade (see Chapter 4).

These measures cannot fully prevent garbage collection pauses, but they can usefully reduce their impact on the application.

# Knowledge, Truth, and Lies

So far in this chapter we have explored the ways in which distributed systems are different from programs running on a single computer: there is no shared memory, only message passing via an unreliable network with variable delays, and the systems may suffer from partial failures, unreliable clocks, and processing pauses.

The consequences of these issues are profoundly disorienting if you're not used to distributed systems. A node in the network cannot *know* anything for sure—it can only make guesses based on the messages it receives (or doesn't receive) via the network. A node can only find out what state another node is in (what data it has stored, whether it is correctly functioning, etc.) by exchanging messages with it. If a remote node doesn't respond, there is no way of knowing what state it is in, because problems in the network cannot reliably be distinguished from problems at a node.

Discussions of these systems border on the philosophical: What do we know to be true or false in our system? How sure can we be of that knowledge, if the mechanisms for perception and measurement are unreliable? Should software systems obey the laws that we expect of the physical world, such as cause and effect?

Fortunately, we don't need to go as far as figuring out the meaning of life. In a distributed system, we can state the assumptions we are making about the behavior (the *system model*) and design the actual system in such a way that it meets those assumptions. Algorithms can be proved to function correctly within a certain system model. This means that reliable behavior is achievable, even if the underlying system model provides very few guarantees.

However, although it is possible to make software well behaved in an unreliable system model, it is not straightforward to do so. In the rest of this chapter we will further explore the notions of knowledge and truth in distributed systems, which will help us think about the kinds of assumptions we can make and the guarantees we may want to provide. In Chapter 9 we will proceed to look at some examples of distributed algorithms that provide particular guarantees under particular assumptions.

## The Truth Is Defined by the Majority

Imagine a network with an asymmetric fault: a node is able to receive all messages sent to it, but any outgoing messages from that node are dropped or delayed [19]. Even though that node is working perfectly well, and is receiving requests from other nodes, the other nodes cannot hear its responses. After some timeout, the other nodes declare it dead, because they haven't heard from the node. The situation unfolds like a nightmare: the semi-disconnected node is dragged to the graveyard, kicking and screaming "I'm not dead!"—but since nobody can hear its screaming, the funeral procession continues with stoic determination.

In a slightly less nightmarish scenario, the semi-disconnected node may notice that the messages it is sending are not being acknowledged by other nodes, and so realize that there must be a fault in the network. Nevertheless, the node is wrongly declared dead by the other nodes, and the semi-disconnected node cannot do anything about it.

As a third scenario, imagine a node that experiences a long stop-the-world garbage collection pause. All of the node's threads are preempted by the GC and paused for one minute, and consequently, no requests are processed and no responses are sent. The other nodes wait, retry, grow impatient, and eventually declare the node dead and load it onto the hearse. Finally, the GC finishes and the node's threads continue as if nothing had happened. The other nodes are surprised as the supposedly dead node suddenly raises its head out of the coffin, in full health, and starts cheerfully chatting with bystanders. At first, the GCing node doesn't even realize that an entire minute has passed and that it was declared dead—from its perspective, hardly any time has passed since it was last talking to the other nodes.

The moral of these stories is that a node cannot necessarily trust its own judgment of a situation. A distributed system cannot exclusively rely on a single node, because a node may fail at any time, potentially leaving the system stuck and unable to recover. Instead, many distributed algorithms rely on a *quorum*, that is, voting among the nodes (see “[Quorums for reading and writing](#)” on page 71): decisions require some minimum number of votes from several nodes in order to reduce the dependence on any one particular node.

That includes decisions about declaring nodes dead. If a quorum of nodes declares another node dead, then it must be considered dead, even if that node still very much feels alive. The individual node must abide by the quorum decision and step down.

Most commonly, the quorum is an absolute majority of more than half the nodes (although other kinds of quorums are possible). A majority quorum allows the system to continue working if individual nodes have failed (with three nodes, one failure can be tolerated; with five nodes, two failures can be tolerated). However, it is still safe, because there can only be only one majority in the system—there cannot be two majorities with conflicting decisions at the same time. We will discuss the use of quorums in more detail when we get to *consensus algorithms* in Chapter 9.

## The leader and the lock

Frequently, a system requires there to be only one of some thing. For example:

- Only one node is allowed to be the leader for a database partition, to avoid split brain (see “[Handling Node Outages](#)” on page 48).
- Only one transaction or client is allowed to hold the lock for a particular resource or object, to prevent concurrently writing to it and corrupting it.

- Only one user is allowed to register a particular username, because a username must uniquely identify a user.

Implementing this in a distributed system requires care: even if a node believes that it is “the chosen one” (the leader of the partition, the holder of the lock, the request handler of the user who successfully grabbed the username), that doesn’t necessarily mean a quorum of nodes agrees! A node may have formerly been the leader, but if the other nodes declared it dead in the meantime (e.g., due to a network interruption or GC pause), it may have been demoted and another leader may have already been elected.

If a node continues acting as the chosen one, even though the majority of nodes have declared it dead, it could cause problems in a system that is not carefully designed. Such a node could send messages to other nodes in its self-appointed capacity, and if other nodes believe it, the system as a whole may do something incorrect.

For example, [Figure 8-4](#) shows a data corruption bug due to an incorrect implementation of locking. (The bug is not theoretical: HBase used to have this problem [74, 75].) Say you want to ensure that a file in a storage service can only be accessed by one client at a time, because if multiple clients tried to write to it, the file would become corrupted. You try to implement this by requiring a client to obtain a lease from a lock service before accessing the file.

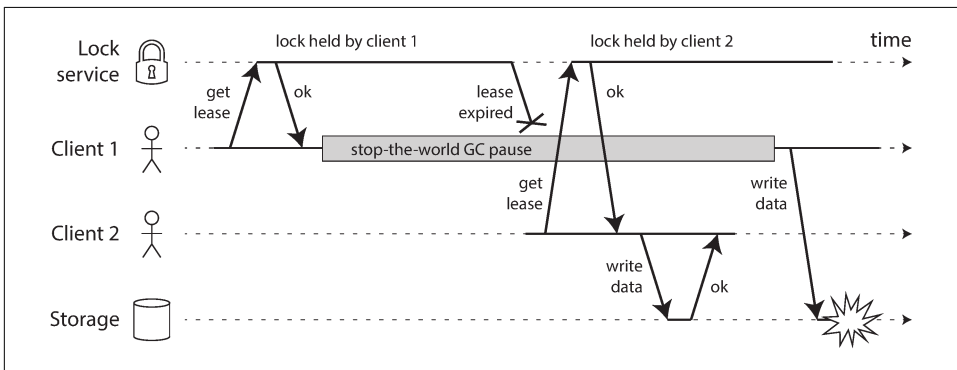

*Figure 8-4. Incorrect implementation of a distributed lock: client 1 believes that it still has a valid lease, even though it has expired, and thus corrupts a file in storage.*

The problem is an example of what we discussed in “[Process Pauses](#)” on page 113: if the client holding the lease is paused for too long, its lease expires. Another client can obtain a lease for the same file, and start writing to the file. When the paused client comes back, it believes (incorrectly) that it still has a valid lease and proceeds to also write to the file. As a result, the clients’ writes clash and corrupt the file.



## Fencing tokens

When using a lock or lease to protect access to some resource, such as the file storage in [Figure 8-4](#), we need to ensure that a node that is under a false belief of being “the chosen one” cannot disrupt the rest of the system. A fairly simple technique that achieves this goal is called *fencing*, and is illustrated in [Figure 8-5](#).

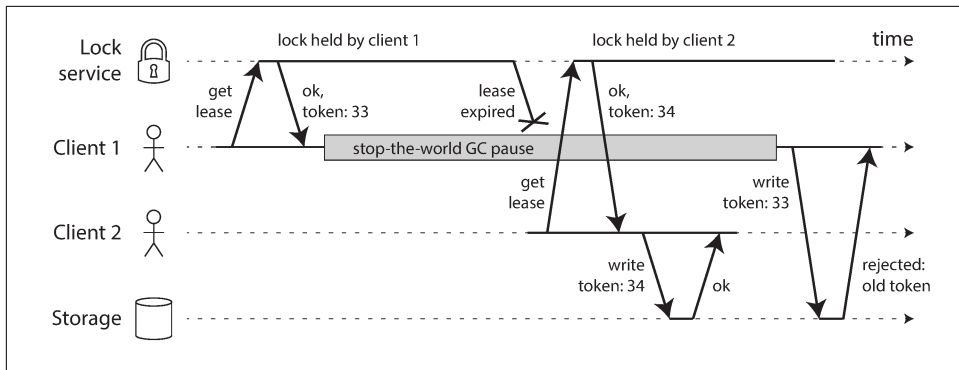

*Figure 8-5. Making access to storage safe by allowing writes only in the order of increasing fencing tokens.*

Let’s assume that every time the lock server grants a lock or lease, it also returns a *fencing token*, which is a number that increases every time a lock is granted (e.g., incremented by the lock service). We can then require that every time a client sends a write request to the storage service, it must include its current fencing token.

In [Figure 8-5](#), client 1 acquires the lease with a token of 33, but then it goes into a long pause and the lease expires. Client 2 acquires the lease with a token of 34 (the number always increases) and then sends its write request to the storage service, including the token of 34. Later, client 1 comes back to life and sends its write to the storage service, including its token value 33. However, the storage server remembers that it has already processed a write with a higher token number (34), and so it rejects the request with token 33.

If ZooKeeper is used as lock service, the transaction ID `zxid` or the node version `cversion` can be used as fencing token. Since they are guaranteed to be monotonically increasing, they have the required properties [74].

Note that this mechanism requires the resource itself to take an active role in checking tokens by rejecting any writes with an older token than one that has already been processed—it is not sufficient to rely on clients checking their lock status themselves. For resources that do not explicitly support fencing tokens, you might still be able work around the limitation (for example, in the case of a file storage service you could include the fencing token in the filename). However, some kind of check is necessary to avoid processing requests outside of the lock’s protection.

Checking a token on the server side may seem like a downside, but it is arguably a good thing: it is unwise for a service to assume that its clients will always be well behaved, because the clients are often run by people whose priorities are very different from the priorities of the people running the service [76]. Thus, it is a good idea for any service to protect itself from accidentally abusive clients.

## Byzantine Faults

Fencing tokens can detect and block a node that is *inadvertently* acting in error (e.g., because it hasn't yet found out that its lease has expired). However, if the node deliberately wanted to subvert the system's guarantees, it could easily do so by sending messages with a fake fencing token.

In this book we assume that nodes are unreliable but honest: they may be slow or never respond (due to a fault), and their state may be outdated (due to a GC pause or network delays), but we assume that if a node *does* respond, it is telling the “truth”: to the best of its knowledge, it is playing by the rules of the protocol.

Distributed systems problems become much harder if there is a risk that nodes may “lie” (send arbitrary faulty or corrupted responses)—for example, if a node may claim to have received a particular message when in fact it didn't. Such behavior is known as a *Byzantine fault*, and the problem of reaching consensus in this untrusting environment is known as the *Byzantine Generals Problem* [77].

### The Byzantine Generals Problem

The Byzantine Generals Problem is a generalization of the so-called *Two Generals Problem* [78], which imagines a situation in which two army generals need to agree on a battle plan. As they have set up camp on two different sites, they can only communicate by messenger, and the messengers sometimes get delayed or lost (like packets in a network). We will discuss this problem of *consensus* in Chapter 9.

In the Byzantine version of the problem, there are  $n$  generals who need to agree, and their endeavor is hampered by the fact that there are some traitors in their midst. Most of the generals are loyal, and thus send truthful messages, but the traitors may try to deceive and confuse the others by sending fake or untrue messages (while trying to remain undiscovered). It is not known in advance who the traitors are.

Byzantium was an ancient Greek city that later became Constantinople, in the place which is now Istanbul in Turkey. There isn't any historic evidence that the generals of Byzantium were any more prone to intrigue and conspiracy than those elsewhere. Rather, the name is derived from *Byzantine* in the sense of *excessively complicated, bureaucratic, devious*, which was used in politics long before computers [79]. Lamport wanted to choose a nationality that would not offend any readers, and he was advised that calling it *The Albanian Generals Problem* was not such a good idea [80].

A system is *Byzantine fault-tolerant* if it continues to operate correctly even if some of the nodes are malfunctioning and not obeying the protocol, or if malicious attackers are interfering with the network. This concern is relevant in certain specific circumstances. For example:

- In aerospace environments, the data in a computer’s memory or CPU register could become corrupted by radiation, leading it to respond to other nodes in arbitrarily unpredictable ways. Since a system failure would be very expensive (e.g., an aircraft crashing and killing everyone on board, or a rocket colliding with the International Space Station), flight control systems must tolerate Byzantine faults [81, 82].
- In a system with multiple participating organizations, some participants may attempt to cheat or defraud others. In such circumstances, it is not safe for a node to simply trust another node’s messages, since they may be sent with malicious intent. For example, peer-to-peer networks like Bitcoin and other blockchains can be considered to be a way of getting mutually untrusting parties to agree whether a transaction happened or not, without relying on a central authority [83].

However, in the kinds of systems we discuss in this book, we can usually safely assume that there are no Byzantine faults. In your datacenter, all the nodes are controlled by your organization (so they can hopefully be trusted) and radiation levels are low enough that memory corruption is not a major problem. Protocols for making systems Byzantine fault-tolerant are quite complicated [84], and fault-tolerant embedded systems rely on support from the hardware level [81]. In most server-side data systems, the cost of deploying Byzantine fault-tolerant solutions makes them impracticable.

Web applications do need to expect arbitrary and malicious behavior of clients that are under end-user control, such as web browsers. This is why input validation, sanitization, and output escaping are so important: to prevent SQL injection and cross-site scripting, for example. However, we typically don’t use Byzantine fault-tolerant protocols here, but simply make the server the authority on deciding what client behavior is and isn’t allowed. In peer-to-peer networks, where there is no such central authority, Byzantine fault tolerance is more relevant.

A bug in the software could be regarded as a Byzantine fault, but if you deploy the same software to all nodes, then a Byzantine fault-tolerant algorithm cannot save you. Most Byzantine fault-tolerant algorithms require a supermajority of more than two-thirds of the nodes to be functioning correctly (i.e., if you have four nodes, at most one may malfunction). To use this approach against bugs, you would have to have four independent implementations of the same software and hope that a bug only appears in one of the four implementations.

Similarly, it would be appealing if a protocol could protect us from vulnerabilities, security compromises, and malicious attacks. Unfortunately, this is not realistic either: in most systems, if an attacker can compromise one node, they can probably compromise all of them, because they are probably running the same software. Thus, traditional mechanisms (authentication, access control, encryption, firewalls, and so on) continue to be the main protection against attackers.

### Weak forms of lying

Although we assume that nodes are generally honest, it can be worth adding mechanisms to software that guard against weak forms of “lying”—for example, invalid messages due to hardware issues, software bugs, and misconfiguration. Such protection mechanisms are not full-blown Byzantine fault tolerance, as they would not withstand a determined adversary, but they are nevertheless simple and pragmatic steps toward better reliability. For example:

- Network packets do sometimes get corrupted due to hardware issues or bugs in operating systems, drivers, routers, etc. Usually, corrupted packets are caught by the checksums built into TCP and UDP, but sometimes they evade detection [85, 86, 87]. Simple measures are usually sufficient protection against such corruption, such as checksums in the application-level protocol.
- A publicly accessible application must carefully sanitize any inputs from users, for example checking that a value is within a reasonable range and limiting the size of strings to prevent denial of service through large memory allocations. An internal service behind a firewall may be able to get away with less strict checks on inputs, but some basic sanity-checking of values (e.g., in protocol parsing [85]) is a good idea.
- NTP clients can be configured with multiple server addresses. When synchronizing, the client contacts all of them, estimates their errors, and checks that a majority of servers agree on some time range. As long as most of the servers are okay, a misconfigured NTP server that is reporting an incorrect time is detected as an outlier and is excluded from synchronization [37]. The use of multiple servers makes NTP more robust than if it only uses a single server.

## System Model and Reality

Many algorithms have been designed to solve distributed systems problems—for example, we will examine solutions for the consensus problem in Chapter 9. In order to be useful, these algorithms need to tolerate the various faults of distributed systems that we discussed in this chapter.

Algorithms need to be written in a way that does not depend too heavily on the details of the hardware and software configuration on which they are run. This in

turn requires that we somehow formalize the kinds of faults that we expect to happen in a system. We do this by defining a *system model*, which is an abstraction that describes what things an algorithm may assume.

With regard to timing assumptions, three system models are in common use:

#### *Synchronous model*

The synchronous model assumes bounded network delay, bounded process pauses, and bounded clock error. This does not imply exactly synchronized clocks or zero network delay; it just means you know that network delay, pauses, and clock drift will never exceed some fixed upper bound [88]. The synchronous model is not a realistic model of most practical systems, because (as discussed in this chapter) unbounded delays and pauses do occur.

#### *Partially synchronous model*

Partial synchrony means that a system behaves like a synchronous system *most of the time*, but it sometimes exceeds the bounds for network delay, process pauses, and clock drift [88]. This is a realistic model of many systems: most of the time, networks and processes are quite well behaved—otherwise we would never be able to get anything done—but we have to reckon with the fact that any timing assumptions may be shattered occasionally. When this happens, network delay, pauses, and clock error may become arbitrarily large.

#### *Asynchronous model*

In this model, an algorithm is not allowed to make any timing assumptions—in fact, it does not even have a clock (so it cannot use timeouts). Some algorithms can be designed for the asynchronous model, but it is very restrictive.

Moreover, besides timing issues, we have to consider node failures. The three most common system models for nodes are:

#### *Crash-stop faults*

In the crash-stop model, an algorithm may assume that a node can fail in only one way, namely by crashing. This means that the node may suddenly stop responding at any moment, and thereafter that node is gone forever—it never comes back.

#### *Crash-recovery faults*

We assume that nodes may crash at any moment, and perhaps start responding again after some unknown time. In the crash-recovery model, nodes are assumed to have stable storage (i.e., nonvolatile disk storage) that is preserved across crashes, while the in-memory state is assumed to be lost.

#### *Byzantine (arbitrary) faults*

Nodes may do absolutely anything, including trying to trick and deceive other nodes, as described in the last section.

For modeling real systems, the partially synchronous model with crash-recovery faults is generally the most useful model. But how do distributed algorithms cope with that model?

### Correctness of an algorithm

To define what it means for an algorithm to be *correct*, we can describe its *properties*. For example, the output of a sorting algorithm has the property that for any two distinct elements of the output list, the element further to the left is smaller than the element further to the right. That is simply a formal way of defining what it means for a list to be sorted.

Similarly, we can write down the properties we want of a distributed algorithm to define what it means to be correct. For example, if we are generating fencing tokens for a lock (see “[Fencing tokens](#)” on page 121), we may require the algorithm to have the following properties:

#### *Uniqueness*

No two requests for a fencing token return the same value.

#### *Monotonic sequence*

If request  $x$  returned token  $t_x$ , and request  $y$  returned token  $t_y$ , and  $x$  completed before  $y$  began, then  $t_x < t_y$ .

#### *Availability*

A node that requests a fencing token and does not crash eventually receives a response.

An algorithm is correct in some system model if it always satisfies its properties in all situations that we assume may occur in that system model. But how does this make sense? If all nodes crash, or all network delays suddenly become infinitely long, then no algorithm will be able to get anything done.

### Safety and liveness

To clarify the situation, it is worth distinguishing between two different kinds of properties: *safety* and *liveness* properties. In the example just given, *uniqueness* and *monotonic sequence* are safety properties, but *availability* is a liveness property.

What distinguishes the two kinds of properties? A giveaway is that liveness properties often include the word “eventually” in their definition. (And yes, you guessed it—*eventual consistency* is a liveness property [89].)

Safety is often informally defined as *nothing bad happens*, and liveness as *something good eventually happens*. However, it’s best to not read too much into those informal definitions, because the meaning of good and bad is subjective. The actual definitions of safety and liveness are precise and mathematical [90]:

- If a safety property is violated, we can point at a particular point in time at which it was broken (for example, if the uniqueness property was violated, we can identify the particular operation in which a duplicate fencing token was returned). After a safety property has been violated, the violation cannot be undone—the damage is already done.
- A liveness property works the other way round: it may not hold at some point in time (for example, a node may have sent a request but not yet received a response), but there is always hope that it may be satisfied in the future (namely by receiving a response).

An advantage of distinguishing between safety and liveness properties is that it helps us deal with difficult system models. For distributed algorithms, it is common to require that safety properties *always* hold, in all possible situations of a system model [88]. That is, even if all nodes crash, or the entire network fails, the algorithm must nevertheless ensure that it does not return a wrong result (i.e., that the safety properties remain satisfied).

However, with liveness properties we are allowed to make caveats: for example, we could say that a request needs to receive a response only if a majority of nodes have not crashed, and only if the network eventually recovers from an outage. The definition of the partially synchronous model requires that eventually the system returns to a synchronous state—that is, any period of network interruption lasts only for a finite duration and is then repaired.

### Mapping system models to the real world

Safety and liveness properties and system models are very useful for reasoning about the correctness of a distributed algorithm. However, when implementing an algorithm in practice, the messy facts of reality come back to bite you again, and it becomes clear that the system model is a simplified abstraction of reality.

For example, algorithms in the crash-recovery model generally assume that data in stable storage survives crashes. However, what happens if the data on disk is corrupted, or the data is wiped out due to hardware error or misconfiguration [91]? What happens if a server has a firmware bug and fails to recognize its hard drives on reboot, even though the drives are correctly attached to the server [92]?

Quorum algorithms (see “[Quorums for reading and writing](#)” on page 71) rely on a node remembering the data that it claims to have stored. If a node may suffer from amnesia and forget previously stored data, that breaks the quorum condition, and thus breaks the correctness of the algorithm. Perhaps a new system model is needed, in which we assume that stable storage mostly survives crashes, but may sometimes be lost. But that model then becomes harder to reason about.

The theoretical description of an algorithm can declare that certain things are simply assumed not to happen—and in non-Byzantine systems, we do have to make some assumptions about faults that can and cannot happen. However, a real implementation may still have to include code to handle the case where something happens that was assumed to be impossible, even if that handling boils down to `printf("Sucks to be you")` and `exit(666)`—i.e., letting a human operator clean up the mess [93]. (This is arguably the difference between computer science and software engineering.)

That is not to say that theoretical, abstract system models are worthless—quite the opposite. They are incredibly helpful for distilling down the complexity of real systems to a manageable set of faults that we can reason about, so that we can understand the problem and try to solve it systematically. We can prove algorithms correct by showing that their properties always hold in some system model.

Proving an algorithm correct does not mean its *implementation* on a real system will necessarily always behave correctly. But it's a very good first step, because the theoretical analysis can uncover problems in an algorithm that might remain hidden for a long time in a real system, and that only come to bite you when your assumptions (e.g., about timing) are defeated due to unusual circumstances. Theoretical analysis and empirical testing are equally important.

## Summary

In this chapter we have discussed a wide range of problems that can occur in distributed systems, including:

- Whenever you try to send a packet over the network, it may be lost or arbitrarily delayed. Likewise, the reply may be lost or delayed, so if you don't get a reply, you have no idea whether the message got through.
- A node's clock may be significantly out of sync with other nodes (despite your best efforts to set up NTP), it may suddenly jump forward or back in time, and relying on it is dangerous because you most likely don't have a good measure of your clock's confidence interval.
- A process may pause for a substantial amount of time at any point in its execution (perhaps due to a stop-the-world garbage collector), be declared dead by other nodes, and then come back to life again without realizing that it was paused.

The fact that such *partial failures* can occur is the defining characteristic of distributed systems. Whenever software tries to do anything involving other nodes, there is the possibility that it may occasionally fail, or randomly go slow, or not respond at all (and eventually time out). In distributed systems, we try to build toler-



ance of partial failures into software, so that the system as a whole may continue functioning even when some of its constituent parts are broken.

To tolerate faults, the first step is to *detect* them, but even that is hard. Most systems don't have an accurate mechanism of detecting whether a node has failed, so most distributed algorithms rely on timeouts to determine whether a remote node is still available. However, timeouts can't distinguish between network and node failures, and variable network delay sometimes causes a node to be falsely suspected of crashing. Moreover, sometimes a node can be in a degraded state: for example, a Gigabit network interface could suddenly drop to 1 Kb/s throughput due to a driver bug [94]. Such a node that is "limping" but not dead can be even more difficult to deal with than a cleanly failed node.

Once a fault is detected, making a system tolerate it is not easy either: there is no global variable, no shared memory, no common knowledge or any other kind of shared state between the machines. Nodes can't even agree on what time it is, let alone on anything more profound. The only way information can flow from one node to another is by sending it over the unreliable network. Major decisions cannot be safely made by a single node, so we require protocols that enlist help from other nodes and try to get a quorum to agree.

If you're used to writing software in the idealized mathematical perfection of a single computer, where the same operation always deterministically returns the same result, then moving to the messy physical reality of distributed systems can be a bit of a shock. Conversely, distributed systems engineers will often regard a problem as trivial if it can be solved on a single computer [5], and indeed a single computer can do a lot nowadays [95]. If you can avoid opening Pandora's box and simply keep things on a single machine, it is generally worth doing so.

However, as discussed in the introduction to Part II, scalability is not the only reason for wanting to use a distributed system. Fault tolerance and low latency (by placing data geographically close to users) are equally important goals, and those things cannot be achieved with a single node.

In this chapter we also went on some tangents to explore whether the unreliability of networks, clocks, and processes is an inevitable law of nature. We saw that it isn't: it is possible to give hard real-time response guarantees and bounded delays in networks, but doing so is very expensive and results in lower utilization of hardware resources. Most non-safety-critical systems choose cheap and unreliable over expensive and reliable.

We also touched on supercomputers, which assume reliable components and thus have to be stopped and restarted entirely when a component does fail. By contrast, distributed systems can run forever without being interrupted at the service level, because all faults and maintenance can be handled at the node level—at least in

theory. (In practice, if a bad configuration change is rolled out to all nodes, that will still bring a distributed system to its knees.)

This chapter has been all about problems, and has given us a bleak outlook. In the next chapter we will move on to solutions, and discuss some algorithms that have been designed to cope with the problems in distributed systems.

---

## References

- [1] Mark Cavage: “[There’s Just No Getting Around It: You’re Building a Distributed System](#),” *ACM Queue*, volume 11, number 4, pages 80-89, April 2013. doi: [10.1145/2466486.2482856](https://doi.org/10.1145/2466486.2482856)
- [2] Jay Kreps: “[Getting Real About Distributed System Reliability](#),” *blog.empathy-box.com*, March 19, 2012.
- [3] Sydney Padua: *The Thrilling Adventures of Lovelace and Babbage: The (Mostly) True Story of the First Computer*. Particular Books, April 2015. ISBN: 978-0-141-98151-2
- [4] Coda Hale: “[You Can’t Sacrifice Partition Tolerance](#),” *codahale.com*, October 7, 2010.
- [5] Jeff Hodges: “[Notes on Distributed Systems for Young Bloods](#),” *somethingsimilar.com*, January 14, 2013.
- [6] Antonio Regalado: “[Who Coined ‘Cloud Computing’?](#),” *technologyreview.com*, October 31, 2011.
- [7] Luiz André Barroso, Jimmy Clidaras, and Urs Hölzle: “[The Datacenter as a Computer: An Introduction to the Design of Warehouse-Scale Machines, Second Edition](#),” *Synthesis Lectures on Computer Architecture*, volume 8, number 3, Morgan & Claypool Publishers, July 2013. doi:[10.2200/S00516ED2V01Y201306CAC024](https://doi.org/10.2200/S00516ED2V01Y201306CAC024), ISBN: 978-1-627-05010-4
- [8] David Fiala, Frank Mueller, Christian Engelmann, et al.: “[Detection and Correction of Silent Data Corruption for Large-Scale High-Performance Computing](#),” at *International Conference for High Performance Computing, Networking, Storage and Analysis (SC12)*, November 2012.
- [9] Arjun Singh, Joon Ong, Amit Agarwal, et al.: “[Jupiter Rising: A Decade of Clos Topologies and Centralized Control in Google’s Datacenter Network](#),” at *Annual Conference of the ACM Special Interest Group on Data Communication (SIGCOMM)*, August 2015. doi:[10.1145/2785956.2787508](https://doi.org/10.1145/2785956.2787508)
- [10] Glenn K. Lockwood: “[Hadoop’s Uncomfortable Fit in HPC](#),” *glennklockwood.blogspot.co.uk*, May 16, 2014.

- [11] John von Neumann: “Probabilistic Logics and the Synthesis of Reliable Organisms from Unreliable Components,” in *Automata Studies (AM-34)*, edited by Claude E. Shannon and John McCarthy, Princeton University Press, 1956. ISBN: 978-0-691-07916-5
- [12] Richard W. Hamming: *The Art of Doing Science and Engineering*. Taylor & Francis, 1997. ISBN: 978-9-056-99500-3
- [13] Claude E. Shannon: “A Mathematical Theory of Communication,” *The Bell System Technical Journal*, volume 27, number 3, pages 379–423 and 623–656, July 1948.
- [14] Peter Bailis and Kyle Kingsbury: “The Network Is Reliable,” *ACM Queue*, volume 12, number 7, pages 48–55, July 2014. doi:10.1145/2639988.2639988
- [15] Joshua B. Leners, Trinabh Gupta, Marcos K. Aguilera, and Michael Walfish: “Taming Uncertainty in Distributed Systems with Help from the Network,” at *10th European Conference on Computer Systems (EuroSys)*, April 2015. doi:10.1145/2741948.2741976
- [16] Phillipa Gill, Navendu Jain, and Nachiappan Nagappan: “Understanding Network Failures in Data Centers: Measurement, Analysis, and Implications,” at *ACM SIGCOMM Conference*, August 2011. doi:10.1145/2018436.2018477
- [17] Mark Imbriaco: “Downtime Last Saturday,” *github.com*, December 26, 2012.
- [18] Will Oremus: “The Global Internet Is Being Attacked by Sharks, Google Confirms,” *slate.com*, August 15, 2014.
- [19] Marc A. Donges: “Re: bnx2 cards Intermittantly Going Offline,” Message to Linux *netdev* mailing list, *spinics.net*, September 13, 2012.
- [20] Kyle Kingsbury: “Call Me Maybe: Elasticsearch,” *aphyr.com*, June 15, 2014.
- [21] Salvatore Sanfilippo: “A Few Arguments About Redis Sentinel Properties and Fail Scenarios,” *antirez.com*, October 21, 2014.
- [22] Bert Hubert: “The Ultimate SO\_LINGER Page, or: Why Is My TCP Not Reliable,” *blog.netherlabs.nl*, January 18, 2009.
- [23] Nicolas Liochon: “CAP: If All You Have Is a Timeout, Everything Looks Like a Partition,” *blog.thislongrun.com*, May 25, 2015.
- [24] Jerome H. Saltzer, David P. Reed, and David D. Clark: “End-To-End Arguments in System Design,” *ACM Transactions on Computer Systems*, volume 2, number 4, pages 277–288, November 1984. doi:10.1145/357401.357402
- [25] Matthew P. Grosvenor, Malte Schwarzkopf, Ionel Gog, et al.: “Queues Don’t Matter When You Can JUMP Them!,” at *12th USENIX Symposium on Networked Systems Design and Implementation (NSDI)*, May 2015.

- [26] Guohui Wang and T. S. Eugene Ng: “[The Impact of Virtualization on Network Performance of Amazon EC2 Data Center](#),” at *29th IEEE International Conference on Computer Communications* (INFOCOM), March 2010. doi:10.1109/INFOCOM.2010.5461931
- [27] Van Jacobson: “[Congestion Avoidance and Control](#),” at *ACM Symposium on Communications Architectures and Protocols* (SIGCOMM), August 1988. doi:10.1145/52324.52356
- [28] Brandon Philips: “[etcd: Distributed Locking and Service Discovery](#),” at *Strange Loop*, September 2014.
- [29] Steve Newman: “[A Systematic Look at EC2 I/O](#),” *blog.scalyr.com*, October 16, 2012.
- [30] Naohiro Hayashibara, Xavier Défago, Rami Yared, and Takuya Katayama: “[The  \$\phi\$  Accrual Failure Detector](#),” Japan Advanced Institute of Science and Technology, School of Information Science, Technical Report IS-RR-2004-010, May 2004.
- [31] Jeffrey Wang: “[Phi Accrual Failure Detector](#),” *ternarysearch.blogspot.co.uk*, August 11, 2013.
- [32] Srinivasan Keshav: *An Engineering Approach to Computer Networking: ATM Networks, the Internet, and the Telephone Network*. Addison-Wesley Professional, May 1997. ISBN: 978-0-201-63442-6
- [33] Cisco, “[Integrated Services Digital Network](#),” *docwiki.cisco.com*.
- [34] Othmar Kyas: *ATM Networks*. International Thomson Publishing, 1995. ISBN: 978-1-850-32128-6
- [35] “[InfiniBand FAQ](#),” Mellanox Technologies, December 22, 2014.
- [36] Jose Renato Santos, Yoshio Turner, and G. (John) Janakiraman: “[End-to-End Congestion Control for InfiniBand](#),” at *22nd Annual Joint Conference of the IEEE Computer and Communications Societies* (INFOCOM), April 2003. Also published by HP Laboratories Palo Alto, Tech Report HPL-2002-359. doi:10.1109/INFOCOM.2003.1208949
- [37] Ulrich Windl, David Dalton, Marc Martinec, and Dale R. Worley: “[The NTP FAQ and HOWTO](#),” *ntp.org*, November 2006.
- [38] John Graham-Cumming: “[How and why the leap second affected Cloudflare DNS](#),” *blog.cloudflare.com*, January 1, 2017.
- [39] David Holmes: “[Inside the Hotspot VM: Clocks, Timers and Scheduling Events – Part I – Windows](#),” *blogs.oracle.com*, October 2, 2006.
- [40] Steve Loughran: “[Time on Multi-Core, Multi-Socket Servers](#),” *steveloughran.blogspot.co.uk*, September 17, 2015.

- [41] James C. Corbett, Jeffrey Dean, Michael Epstein, et al.: “[Spanner: Google’s Globally-Distributed Database](#),” at *10th USENIX Symposium on Operating System Design and Implementation (OSDI)*, October 2012.
- [42] M. Caporali and R. Ambrosini: “[How Closely Can a Personal Computer Clock Track the UTC Timescale Via the Internet?](#),” *European Journal of Physics*, volume 23, number 4, pages L17–L21, June 2012. doi:10.1088/0143-0807/23/4/103
- [43] Nelson Minar: “[A Survey of the NTP Network](#),” *alumni.media.mit.edu*, December 1999.
- [44] Viliam Holub: “[Synchronizing Clocks in a Cassandra Cluster Pt. 1 – The Problem](#),” *blog.rapid7.com*, March 14, 2014.
- [45] Poul-Henning Kamp: “[The One-Second War \(What Time Will You Die?\)](#),” *ACM Queue*, volume 9, number 4, pages 44–48, April 2011. doi:10.1145/1966989.1967009
- [46] Nelson Minar: “[Leap Second Crashes Half the Internet](#),” *somebits.com*, July 3, 2012.
- [47] Christopher Pascoe: “[Time, Technology and Leaping Seconds](#),” *googleblog.blogspot.co.uk*, September 15, 2011.
- [48] Mingxue Zhao and Jeff Barr: “[Look Before You Leap – The Coming Leap Second and AWS](#),” *aws.amazon.com*, May 18, 2015.
- [49] Darryl Veitch and Kanthaiyah Vijayalayan: “[Network Timing and the 2015 Leap Second](#),” at *17th International Conference on Passive and Active Measurement (PAM)*, April 2016. doi:10.1007/978-3-319-30505-9\_29
- [50] “[Timekeeping in VMware Virtual Machines](#),” Information Guide, VMware, Inc., December 2011.
- [51] “[MiFID II / MiFIR: Regulatory Technical and Implementing Standards – Annex I \(Draft\)](#),” European Securities and Markets Authority, Report ESMA/2015/1464, September 2015.
- [52] Luke Bigum: “[Solving MiFID II Clock Synchronisation With Minimum Spend \(Part 1\)](#),” *lmax.com*, November 27, 2015.
- [53] Kyle Kingsbury: “[Call Me Maybe: Cassandra](#),” *aphyr.com*, September 24, 2013.
- [54] John Daily: “[Clocks Are Bad, or, Welcome to the Wonderful World of Distributed Systems](#),” *riak.com*, November 12, 2013.
- [55] Kyle Kingsbury: “[The Trouble with Timestamps](#),” *aphyr.com*, October 12, 2013.

- [56] Leslie Lamport: “Time, Clocks, and the Ordering of Events in a Distributed System,” *Communications of the ACM*, volume 21, number 7, pages 558–565, July 1978. doi:10.1145/359545.359563
- [57] Sandeep Kulkarni, Murat Demirbas, Deepak Madeppa, et al.: “Logical Physical Clocks and Consistent Snapshots in Globally Distributed Databases,” State University of New York at Buffalo, Computer Science and Engineering Technical Report 2014-04, May 2014.
- [58] Justin Sheehy: “There Is No Now: Problems With Simultaneity in Distributed Systems,” *ACM Queue*, volume 13, number 3, pages 36–41, March 2015. doi:10.1145/2733108
- [59] Murat Demirbas: “Spanner: Google’s Globally-Distributed Database,” *muratbuffalo.blogspot.co.uk*, July 4, 2013.
- [60] Dahlia Malkhi and Jean-Philippe Martin: “Spanner’s Concurrency Control,” *ACM SIGACT News*, volume 44, number 3, pages 73–77, September 2013. doi:10.1145/2527748.2527767
- [61] Manuel Bravo, Nuno Diegues, Jingna Zeng, et al.: “On the Use of Clocks to Enforce Consistency in the Cloud,” *IEEE Data Engineering Bulletin*, volume 38, number 1, pages 18–31, March 2015.
- [62] Spencer Kimball: “Living Without Atomic Clocks,” *cockroachlabs.com*, February 17, 2016.
- [63] Cary G. Gray and David R. Cheriton: “Leases: An Efficient Fault-Tolerant Mechanism for Distributed File Cache Consistency,” at *12th ACM Symposium on Operating Systems Principles (SOSP)*, December 1989. doi:10.1145/74850.74870
- [64] Todd Lipcon: “Avoiding Full GCs in Apache HBase with MemStore-Local Allocation Buffers: Part 1,” *blog.cloudera.com*, February 24, 2011.
- [65] Martin Thompson: “Java Garbage Collection Distilled,” *mechanical-sympathy.blogspot.co.uk*, July 16, 2013.
- [66] Alexey Ragozin: “How to Tame Java GC Pauses? Surviving 16GiB Heap and Greater,” *dzone.com*, June 28, 2011.
- [67] Christopher Clark, Keir Fraser, Steven Hand, et al.: “Live Migration of Virtual Machines,” at *2nd USENIX Symposium on Symposium on Networked Systems Design & Implementation (NSDI)*, May 2005.
- [68] Mike Shaver: “fsyncers and Curveballs,” *shaver.off.net*, May 25, 2008.
- [69] Zhenyun Zhuang and Cuong Tran: “Eliminating Large JVM GC Pauses Caused by Background IO Traffic,” *engineering.linkedin.com*, February 10, 2016.

- [70] David Terei and Amit Levy: “[Blade: A Data Center Garbage Collector](#),” arXiv: 1504.02578, April 13, 2015.
- [71] Martin Maas, Tim Harris, Krste Asanović, and John Kubiawicz: “[Trash Day: Coordinating Garbage Collection in Distributed Systems](#),” at *15th USENIX Workshop on Hot Topics in Operating Systems (HotOS)*, May 2015.
- [72] “[Predictable Low Latency](#),” Cinnober Financial Technology AB, *cinnober.com*, November 24, 2013.
- [73] Martin Fowler: “[The LMAX Architecture](#),” *martinfowler.com*, July 12, 2011.
- [74] Flavio P. Junqueira and Benjamin Reed: *ZooKeeper: Distributed Process Coordination*. O’Reilly Media, 2013. ISBN: 978-1-449-36130-3
- [75] Enis Söztutar: “[HBase and HDFS: Understanding Filesystem Usage in HBase](#),” at *HBaseCon*, June 2013.
- [76] Caitie McCaffrey: “[Clients Are Jerks: AKA How Halo 4 DoSed the Services at Launch & How We Survived](#),” *caitiem.com*, June 23, 2015.
- [77] Leslie Lamport, Robert Shostak, and Marshall Pease: “[The Byzantine Generals Problem](#),” *ACM Transactions on Programming Languages and Systems (TOPLAS)*, volume 4, number 3, pages 382–401, July 1982. doi:10.1145/357172.357176
- [78] Jim N. Gray: “[Notes on Data Base Operating Systems](#),” in *Operating Systems: An Advanced Course*, Lecture Notes in Computer Science, volume 60, edited by R. Bayer, R. M. Graham, and G. Seegmüller, pages 393–481, Springer-Verlag, 1978. ISBN: 978-3-540-08755-7
- [79] Brian Palmer: “[How Complicated Was the Byzantine Empire?](#),” *slate.com*, October 20, 2011.
- [80] Leslie Lamport: “[My Writings](#),” *lamport.azurewebsites.net*, December 16, 2014. This page can be found by searching the web for the 23-character string obtained by removing the hyphens from the string `allla-mpoort-spubso-ntheweb`.
- [81] John Rushby: “[Bus Architectures for Safety-Critical Embedded Systems](#),” at *1st International Workshop on Embedded Software (EMSOFT)*, October 2001.
- [82] Jake Edge: “[ELC: SpaceX Lessons Learned](#),” *lwn.net*, March 6, 2013.
- [83] Andrew Miller and Joseph J. LaViola, Jr.: “[Anonymous Byzantine Consensus from Moderately-Hard Puzzles: A Model for Bitcoin](#),” University of Central Florida, Technical Report CS-TR-14-01, April 2014.
- [84] James Mickens: “[The Saddest Moment](#),” *USENIX ;login: logout*, May 2013.
- [85] Evan Gilman: “[The Discovery of Apache ZooKeeper’s Poison Packet](#),” *pagerduty.com*, May 7, 2015.

- [86] Jonathan Stone and Craig Partridge: “When the CRC and TCP Checksum Disagree,” at *ACM Conference on Applications, Technologies, Architectures, and Protocols for Computer Communication (SIGCOMM)*, August 2000. doi:10.1145/347059.347561
- [87] Evan Jones: “How Both TCP and Ethernet Checksums Fail,” *evanjones.ca*, October 5, 2015.
- [88] Cynthia Dwork, Nancy Lynch, and Larry Stockmeyer: “Consensus in the Presence of Partial Synchrony,” *Journal of the ACM*, volume 35, number 2, pages 288–323, April 1988. doi:10.1145/42282.42283
- [89] Peter Bailis and Ali Ghodsi: “Eventual Consistency Today: Limitations, Extensions, and Beyond,” *ACM Queue*, volume 11, number 3, pages 55-63, March 2013. doi:10.1145/2460276.2462076
- [90] Bowen Alpern and Fred B. Schneider: “Defining Liveness,” *Information Processing Letters*, volume 21, number 4, pages 181–185, October 1985. doi:10.1016/0020-0190(85)90056-0
- [91] Flavio P. Junqueira: “Dude, Where’s My Metadata?,” *fpj.me*, May 28, 2015.
- [92] Scott Sanders: “January 28th Incident Report,” *github.com*, February 3, 2016.
- [93] Jay Kreps: “A Few Notes on Kafka and Jepsen,” *blog.empathybox.com*, September 25, 2013.
- [94] Thanh Do, Mingzhe Hao, Tanakorn Leesatapornwongsa, et al.: “Limplock: Understanding the Impact of Limpware on Scale-out Cloud Systems,” at *4th ACM Symposium on Cloud Computing (SoCC)*, October 2013. doi:10.1145/2523616.2523627
- [95] Frank McSherry, Michael Isard, and Derek G. Murray: “Scalability! But at What COST?,” at *15th USENIX Workshop on Hot Topics in Operating Systems (HotOS)*, May 2015.



## About the Author

---

**Martin Kleppmann** is a researcher in distributed systems at the University of Cambridge, UK. Previously he was a software engineer and entrepreneur at internet companies including LinkedIn and Rapportive, where he worked on large-scale data infrastructure. In the process he learned a few things the hard way, and he hopes this book will save you from repeating the same mistakes.

Martin is a regular conference speaker, blogger, and open source contributor. He believes that profound technical ideas should be accessible to everyone, and that deeper understanding will help us develop better software.

## Colophon

---

The animal on the cover of *Designing Data-Intensive Applications* is an Indian wild boar (*Sus scrofa cristatus*), a subspecies of wild boar found in India, Myanmar, Nepal, Sri Lanka, and Thailand. They are distinctive from European boars in that they have higher back bristles, no woolly undercoat, and a larger, straighter skull.

The Indian wild boar has a coat of gray or black hair, with stiff bristles running along the spine. Males have protruding canine teeth (called tusks) that are used to fight with rivals or fend off predators. Males are larger than females, but the species averages 33–35 inches tall at the shoulder and 200–300 pounds in weight. Their natural predators include bears, tigers, and various big cats.

These animals are nocturnal and omnivorous—they eat a wide variety of things, including roots, insects, carrion, nuts, berries, and small animals. Wild boars are also known to root through garbage and crop fields, causing a great deal of destruction and earning the enmity of farmers. They need to eat 4,000–4,500 calories a day. Boars have a well-developed sense of smell, which helps them forage for underground plant material and burrowing animals. However, their eyesight is poor.

Wild boars have long held significance in human culture. In Hindu lore, the boar is an avatar of the god Vishnu. In ancient Greek funerary monuments, it was a symbol of a gallant loser (in contrast to the victorious lion). Due to its aggression, it was depicted on the armor and weapons of Scandinavian, Germanic, and Anglo-Saxon warriors. In the Chinese zodiac, it symbolizes determination and impetuosity.

Many of the animals on O'Reilly covers are endangered; all of them are important to the world. To learn more about how you can help, go to [animals.oreilly.com](http://animals.oreilly.com).

The cover image is from Shaw's *Zoology*. The cover fonts are URW Typewriter and Guardian Sans. The text font is Adobe Minion Pro; the font in diagrams is Adobe Myriad Pro; the heading font is Adobe Myriad Condensed; and the code font is Dalton Maag's Ubuntu Mono.